

CATALOGUE

SitForm.
redefine your space

SitForm.

redefine your space

O NAMA

Kompanija SitForm d.o.o., sa sjedištem u ulici Kolodvorska 12, Sarajevo, je kompanija specijalizirana za prodaju visokokvalitetnog namještaja, koja prati najnovija dostignuća u pogledu proizvodnje, materijala i dizajna. SitForm d.o.o. radi na povjerenju klijenata, stvara ugodnu sredinu za kupovinu, u kojoj naši klijenti imaju veliki izbor namještaja.

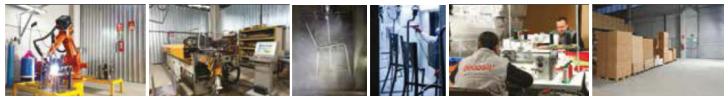

Naši klijenti će u SitForm-u pronaći najbolji kvalitet čiji koncept možemo samo opisati riječima moderan, udoban i dizajniran.

TRADITION MEETS INNOVATION
TO CREATE NEW INSPIRATION





Index

07	SOFAS	322	POUFS
74	ARMCHAIRS	337	BEDS
123	COFFEE TABLES	366	MIRRORS
212	CHAIRS	379	CONTRACT
240	TABLES	407	OUTDOOR
268	SIDE BOARDS		



comfort aesthetics, and longevity



Naturality of Norde...
simple choices of modernity & design...





YUI SOFA

TECHNICAL SPECIFICATIONS

INTERIOR STRUCTURE BEECH HARDWOOD FRAME AND ZIGZAG BOW

SEAT CUSHION 35 DNS SOFT FOAM AND FIBER

BACK GOOSE DOWN AND FIBER

UPHOLSTERY TIGHT

MAINTENANCE ALL DECORATIVE CUSHIONS ARE GOOSE DOWN AND SILICON MIX. QUANTITY AND DIMENSIONS ARE AS PER TECHNICAL DRAWINGS. STANDART WITH 4 CUSHIONS

We recommend shaking and fluffing-up the cushions regularly to maintain the shape. This should be done after removing the cushions from the structure for improved air circulation. For maintenance of fabric and leather, please contact your retailer.



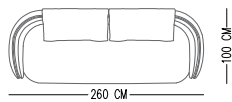
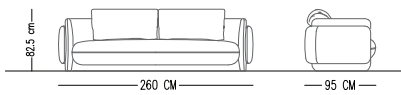

STANDARDS

SOFA - 230 CM	SOFA - 240 CM	SOFA - 250 CM	SOFA - 260 CM

Catalog product-fabric

Nubuck-103



501

Alternative fabric
Linen, Boucle and Linen Teddy

Catalog product-Legs

Hidden leg



JUPITER SOFA

TECHNICAL SPECIFICATIONS

INTERIOR STRUCTURE BEECH HARDWOOD FRAME AND ZIGZAG BOW

SEAT CUSHION 35 DNS SOFT FOAM AND FIBER

BACK GOOSE DOWN AND FIBER

UPHOLSTERY TIGHT

MAINTENANCE ALL DECORATIVE CUSHIONS ARE GOOSE DOWN AND SILICON MIX. QUANTITY AND DIMENSIONS ARE AS PER TECHNICAL DRAWINGS, STANDART WITH 4 CUSHIONS

We recommend shaking and fluffing-up the cushions regularly to maintain the shape. This should be done after removing the cushions from the structure for improved air circulation. For maintenance of fabric and leather, please contact your retailer.



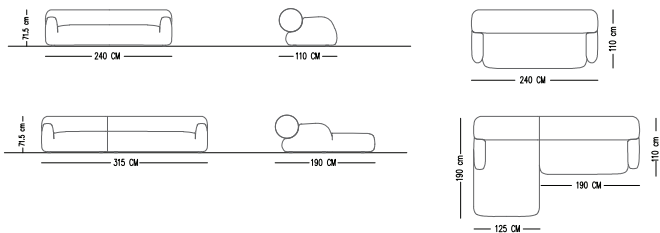

STANDARDS

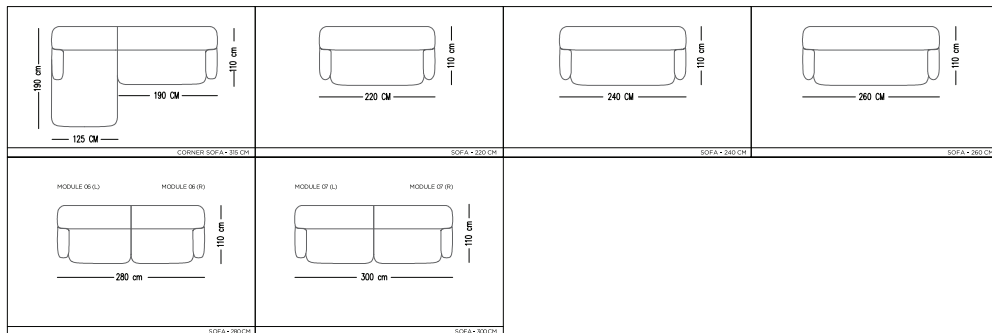

MODULES

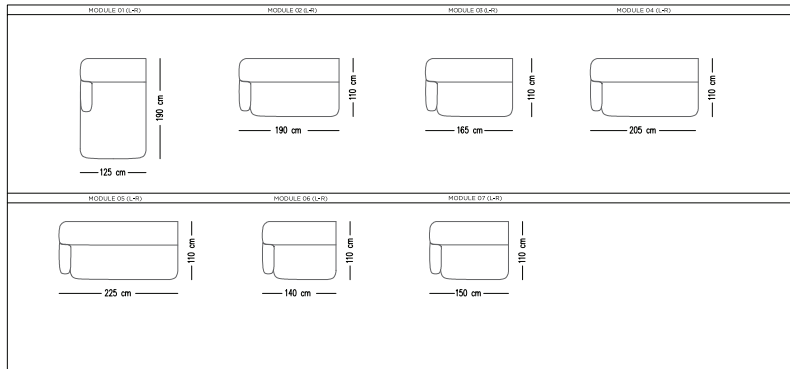

Catalog product-fabric

N-C45/Linen teddy



1048

Catalog product-Legs

Hidden leg

Alternative fabric
Linen, Boucle, Faux leather and Linen teddy



VIENTOS SOFA

TECHNICAL SPECIFICATIONS

INTERIOR STRUCTURE BEECH HARDWOOD FRAME AND ZIGZAG BOW

SEAT CUSHION 35 DNS SOFT FOAM AND FIBER

BACK GOOSE DOWN AND FIBER

UPHOLSTERY TIGHT

MAINTENANCE ALL DECORATIVE CUSHIONS ARE GOOSE DOWN AND SILICON MIX, QUANTITY AND DIMENSIONS ARE AS PER TECHNICAL DRAWINGS. STANDART WITH 4 CUSHIONS

We recommend shaking and fluffing-up the cushions regularly to maintain the shape. This should be done after removing the cushions from the structure for improved air circulation. For maintenance of fabric and leather, please contact your retailer.



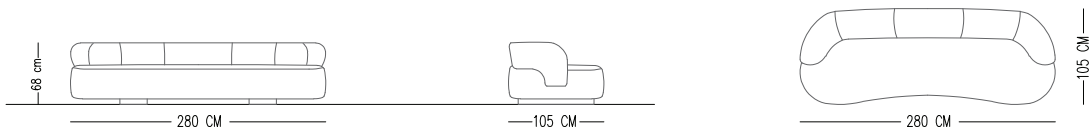

STANDARDS

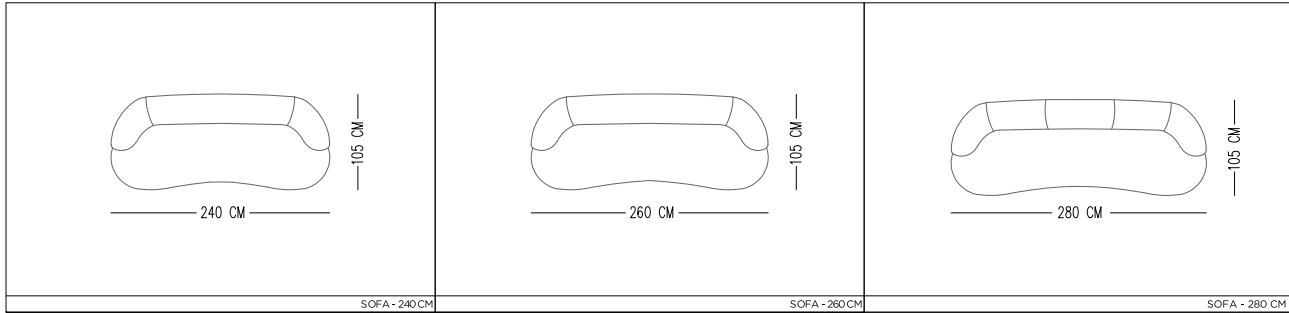

Catalog product-fabric

NB-36/Linen Teddy



2002

Catalog product-Legs

NB-36/Linen Teddy



2002

Alternative fabric
Linen, Boucle, Faux leather



VIBE SOFA

TECHNICAL SPECIFICATIONS

INTERIOR STRUCTURE BEECH HARDWOOD FRAME AND ZIGZAG BOW

SEAT CUSHION 35 DNS SOFT FOAM AND FIBER

BACK GOOSE DOWN AND FIBER

UPHOLSTERY TIGHT

MAINTENANCE ALL DECORATIVE CUSHIONS ARE GOOSE DOWN AND SILICON MIX. QUANTITY AND DIMENSIONS ARE AS PER TECHNICAL DRAWINGS. STANDART WITH 4 CUSHIONS

We recommend shaking and fluffing-up the cushions regularly to maintain the shape. This should be done after removing the cushions from the structure for improved air circulation. For maintenance of fabric and leather, please contact your retailer.



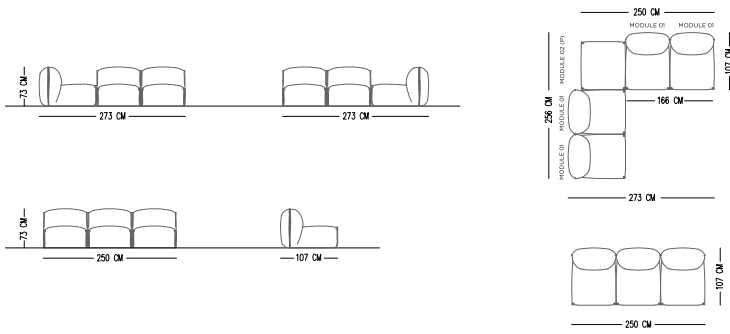

STANDARDS

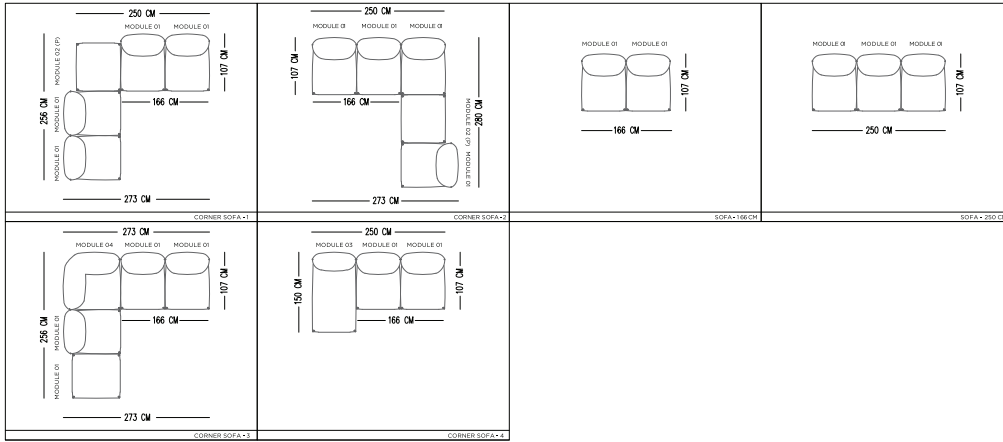

MODULES

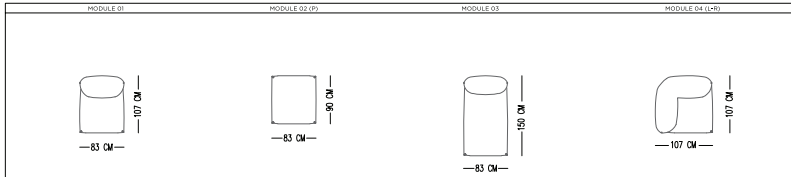

Catalog product-fabric

N-A40/Linen



Nata

Alternative fabric
Linen, Boucle and Linen teddy

Catalog product-Legs

Hidden leg



DOMINO SOFA

TECHNICAL SPECIFICATIONS

INTERIOR STRUCTURE BEECH HARDWOOD FRAME AND ZIGZAG BOW

SEAT CUSHION GOOSE DOWN AND FIBER

BACK GOOSE DOWN

UPHOLSTERY TIGHT

MAINTENANCE ALL DECORATIVE CUSHIONS ARE GOOSE DOWN AND SILICON MIX, QUANTITY AND DIMENSIONS ARE AS PER TECHNICAL.

We recommend shaking and fluffing-up the cushions regularly to maintain the shape. This should be done after removing the cushions from the structure for improved air circulation, For maintenance of fabric and leather, please contact your retailer.



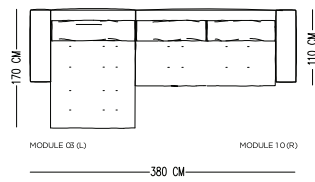
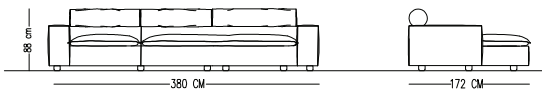

STANDARDS

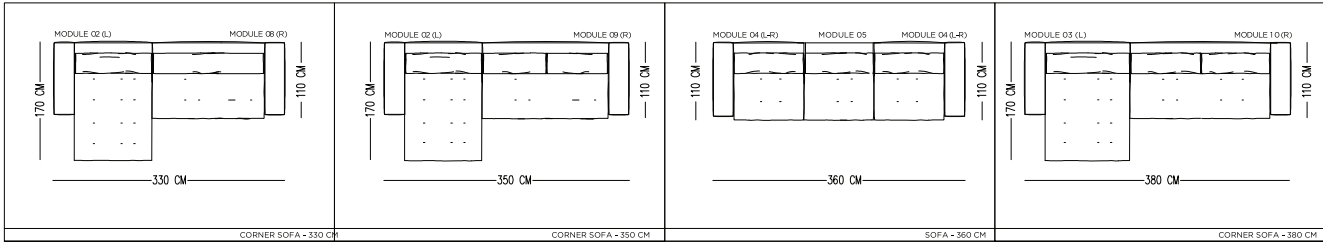

MODULES

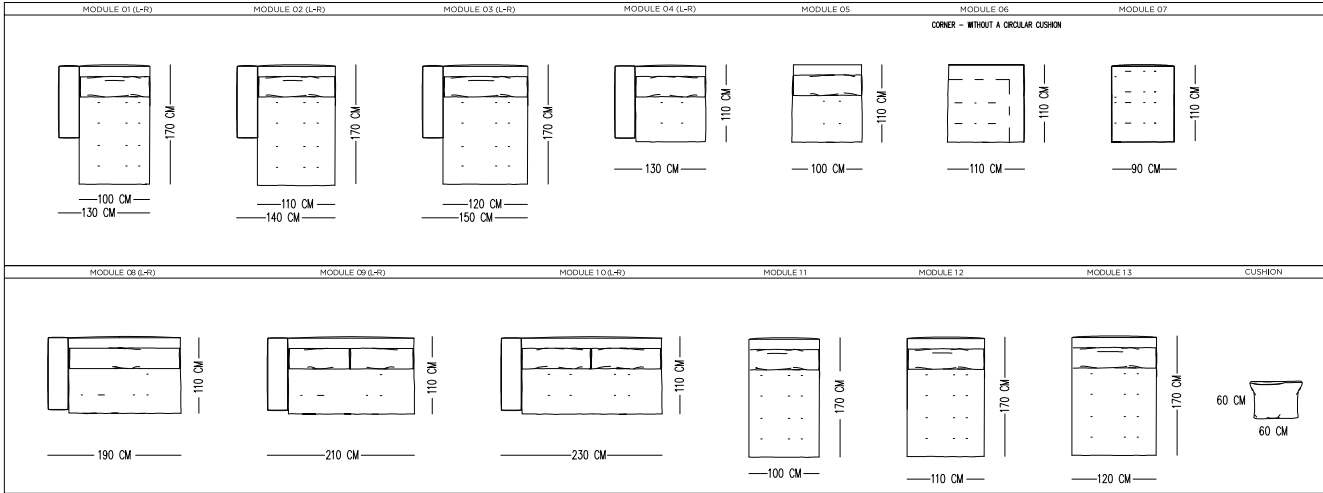

Catalog product-fabric

N-A38/Soft Velvet



15 Frost

Alternative fabric
Linen, Soft velvet and Nubuck

Catalog product-Legs

Hidden leg

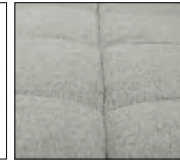

BULUT SOFA

TECHNICAL SPECIFICATIONS

INTERIOR STRUCTURE	BEECH WOOD AND MDF STEEL AND MDF WITH ZIGZAG BOW
SEAT CUSHION	35 DNS SOFT FOAM ON PAD GOOSE DOWN
BACK	BACK CUSHION 100% DOWN/FEATHERS
UPHOLSTERY	LOOSE
MAINTENANCE	<p>ALL DECORATIVE CUSHIONS ARE GOOSE DOWN AND SILICON MIX. QUANTITY AND DIMENSIONS ARE AS PER TECHNICAL DRAWINGS..STANDART WITH 2 CUSHIONS 60*60, 2 CUSHIONS 45*45,1 CUSHIONS 35*55.</p> <p>We recommend shaking and fluffing-up the cushions regularly to maintain the shape. This should be done after removing the cushions from the structure for improved air circulation. For maintenance of fabric and leather, please contact your retailer.</p>



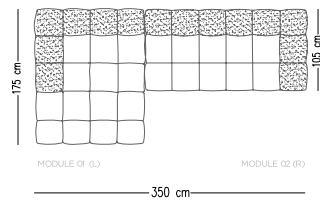
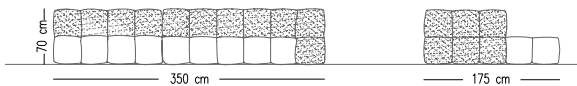

STANDARDS

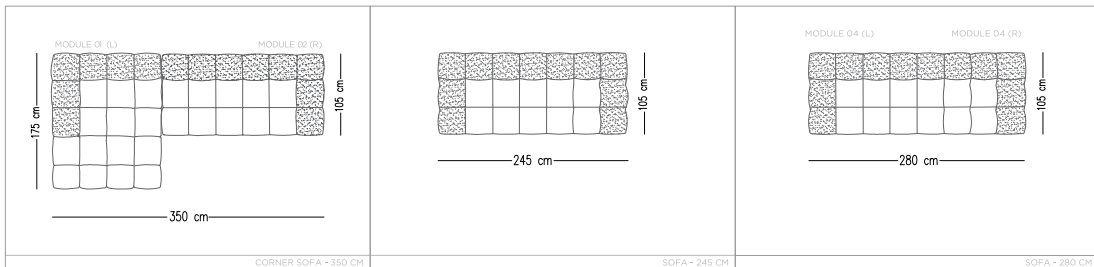

MODULES

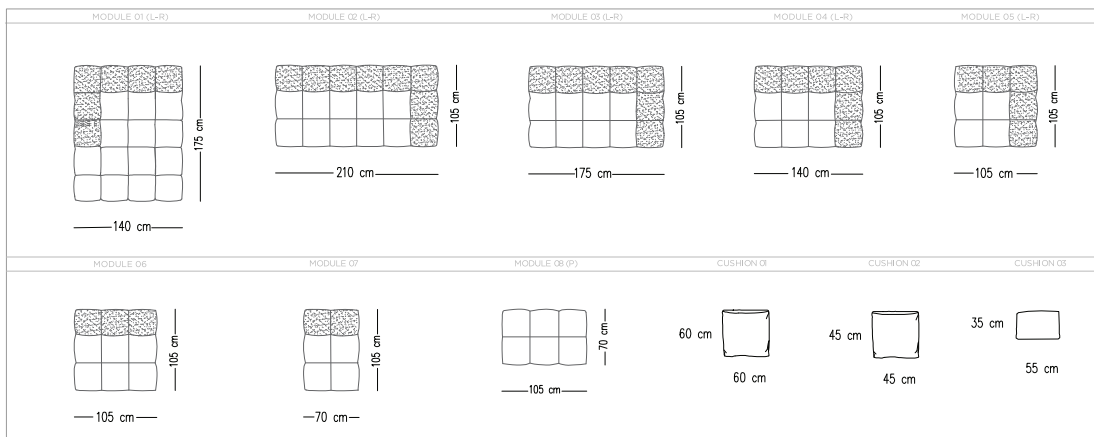

Catalog product-fabric

N-B13/Linen



A.GRI - 01

Alternative fabric
Plush Linen, Suede, Linen and Curl

Catalog product-Legs

Hidden leg



MARLON SOFA

TECHNICAL SPECIFICATIONS

INTERIOR STRUCTURE FRAME BEECH CONTRA, STEEL AND ZIGZAG BOW

SEAT CUSHION GOOSE DOWN AND FIBER MIX

BACK GOOSE DOWN AND FIBER MIX

UPHOLSTERY TIGHT

MAINTENANCE ALL DECORATIVE CUSHIONS ARE GOOSE DOWN AND SILICON MIX, QUANTITY AND DIMENSIONS ARE AS PER TECHNICAL DRAWINGS. STANDART WITH 2 CUSHIONS 50*50.

We recommend shaking and fluffing-up the cushions regularly to maintain the shape. This should be done after removing the cushions from the structure for improved air circulation. For maintenance of fabric and leather, please contact your retailer.



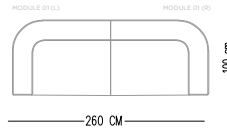
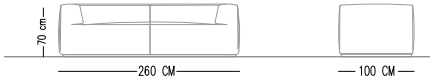
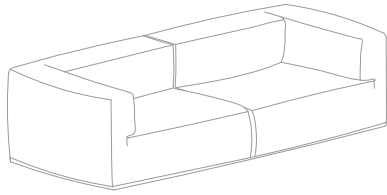

STANDARDS

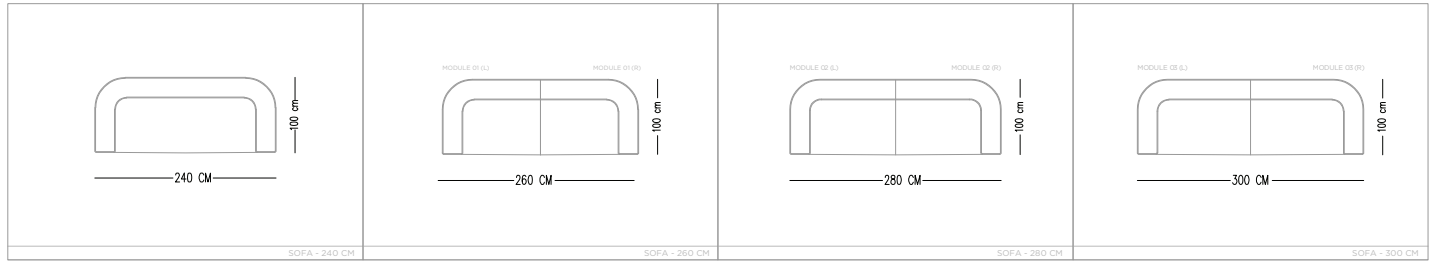

MODULES

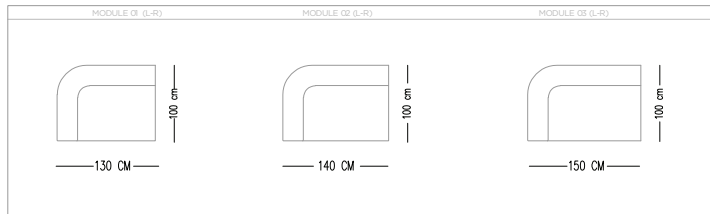

Catalog product-fabric

N-C19/Linen



21556-03

Catalog product-Legs

Hidden Wooden base and leg

Alternative fabric
Linen, Boucle and Nubuck



ITALS SOFA

TECHNICAL SPECIFICATIONS

INTERIOR STRUCTURE BEECH HARDWOOD FRAME AND ELASTIC COLUMN

SEAT CUSHION GOOSE DOWN AND FIBER MIX

BACK GOOSE DOWN AND FIBER MIX

UPHOLSTERY TIGHT

MAINTENANCE ALL DECORATIVE CUSHIONS ARE GOOSE DOWN AND SILICON MIX, QUANTITY AND DIMENSIONS ARE AS PER TECHNICAL DRAWINGS. STANDART WITH 3 CUSHIONS 25*55, 1 CUSHIONS 45*45

We recommend shaking and fluffing-up the cushions regularly to maintain the shape. This should be done after removing the cushions from the structure for improved air circulation. For maintenance of fabric and leather, please contact your retailer.



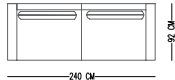
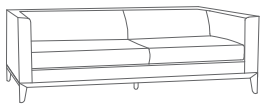

STANDARDS

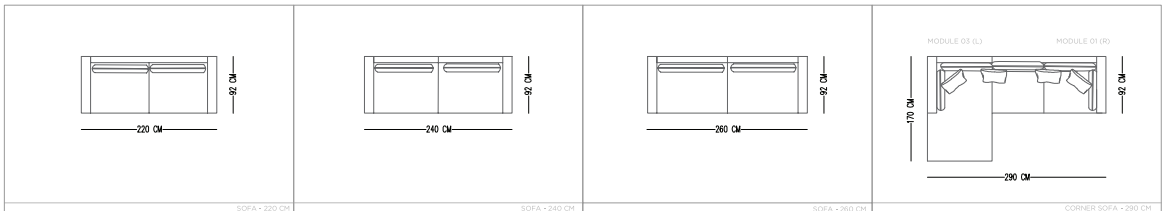

MODULES

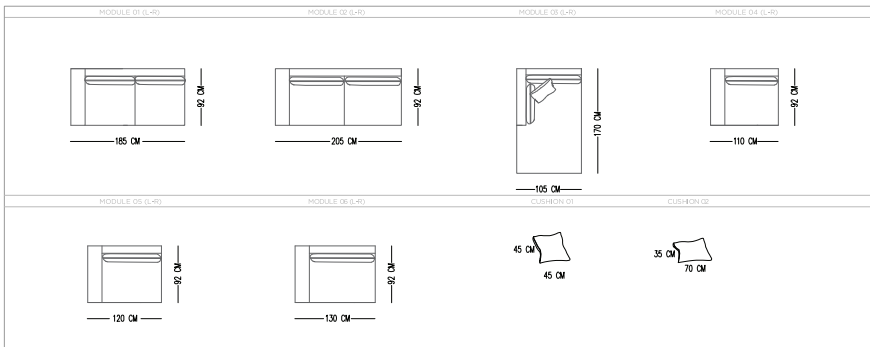

Catalog product-fabric

N-B13/Linen



KREM-01

Alternative fabric
Linen and Boucle

Catalog product-Legs

Wooden walnut polish





NIRVANA SOFA

TECHNICAL SPECIFICATIONS

INTERIOR STRUCTURE FRAME BEECH CONTRA AND ELASTIC COLUMN

SEAT CUSHION 35 DNS SOFT FOAM

BACK 22 DNS GREY FOAM

UPHOLSTERY TIGHT

MAINTENANCE ALL DECORATIVE CUSHIONS ARE GOOSE DOWN AND SILICON MIX, QUANTITY AND DIMENSIONS ARE AS PER TECHNICAL DRAWINGS. STANDART WITH 4 CUSHIONS 50*50, 5 CUSHIONS 50*70

We recommend shaking and fluffing-up the cushions regularly to maintain the shape. This should be done after removing the cushions from the structure for improved air circulation. For maintenance of fabric and leather, please contact your retailer.

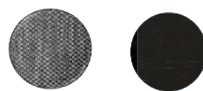

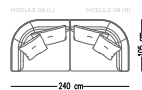
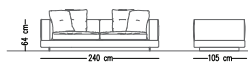
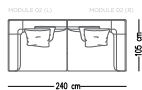

STANDARDS

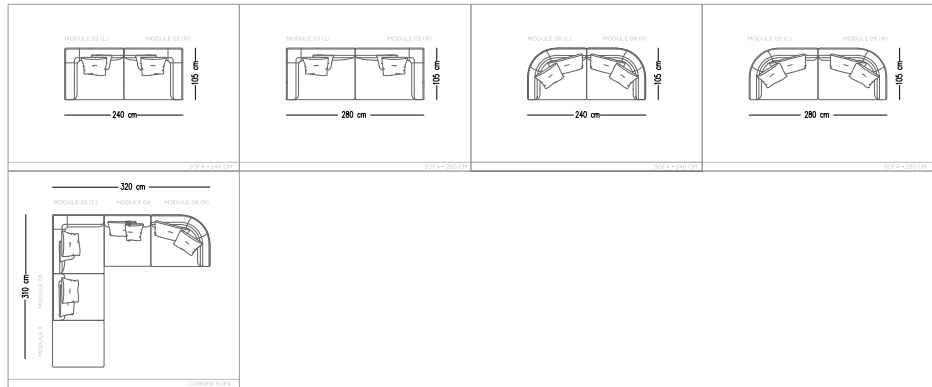

MODULES

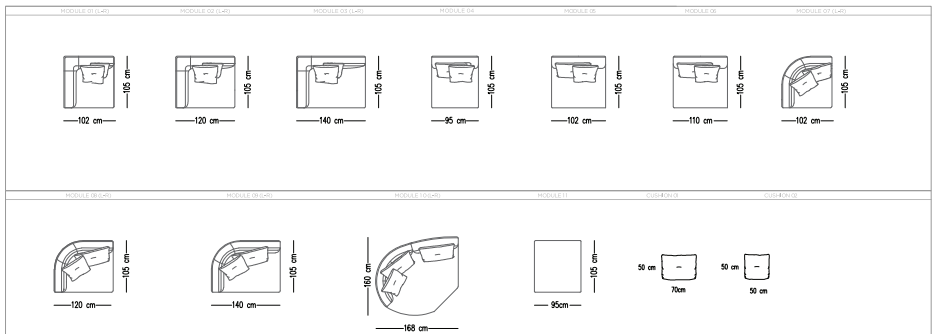

Catalog product-fabric

N-C25/Linen



23

Catalog product-Legs

Wood wenge varnish



Alternative fabric
Linen, Boucle and Chenille



PORTO SOFA

TECHNICAL SPECIFICATIONS

INTERIOR STRUCTURE FRAME BEECH CONTRA AND ELASTIC COLUMN

SEAT CUSHION 35 DNS SOFT FOAM

BACK 22 DNS GREY FOAM

UPHOLSTERY TIGHT

MAINTENANCE ALL DECORATIVE CUSHIONS ARE GOOSE DOWN AND SILICON MIX, QUANTITY AND DIMENSIONS ARE AS PER TECHNICAL DRAWINGS. STANDART WITH 4 CUSHIONS 50*50, 5 CUSHIONS 50*70

We recommend shaking and fluffing-up the cushions regularly to maintain the shape. This should be done after removing the cushions from the structure for improved air circulation. For maintenance of fabric and leather, please contact your retailer.



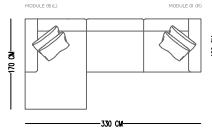
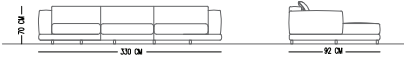

STANDARDS

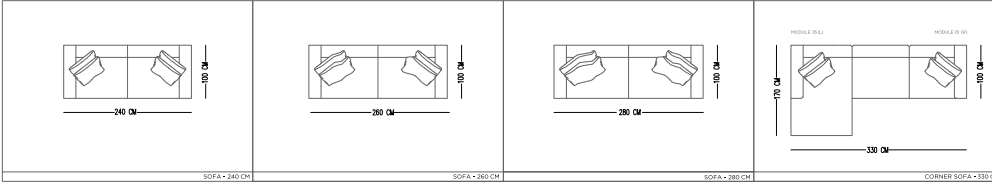

MODULES

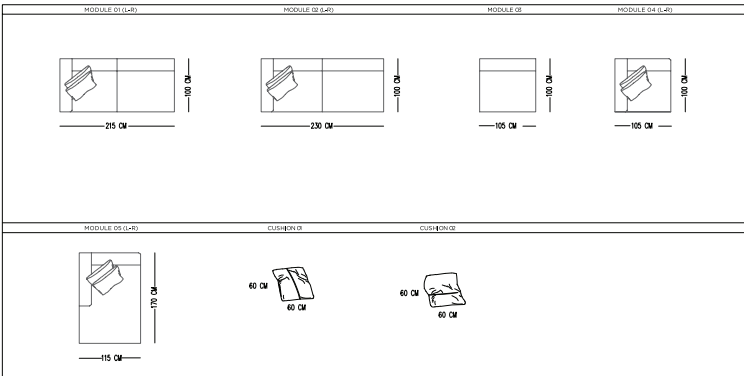

Catalog product-fabric

Linen-12



10

Alternative fabric
Linen and Boucle

Catalog product-Legs

Wood wenge varnish





NORA SOFA

TECHNICAL SPECIFICATIONS

INTERIOR STRUCTURE BEECH WOOD AND STEEL ZIGZAG BOW

SEAT CUSHION GOOSE DOWN AND FIBER MIX

BACK GOOSE DOWN AND FIBER MIX

UPHOLSTERY TIGHT

MAINTENANCE ALL DECORATIVE CUSHIONS ARE GOOSE DOWN AND SILICON MIX, QUANTITY AND DIMENSIONS ARE AS PER TECHNICAL DRAWINGS. STANDART WITH 6 CUSHIONS 55*55.

We recommend shaking and fluffing-up the cushions regularly to maintain the shape. This should be done after removing the cushions from the structure for improved air circulation. For maintenance of fabric and leather, please contact your retailer.



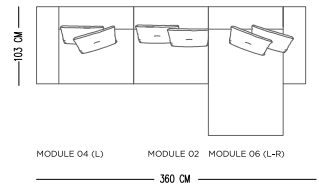
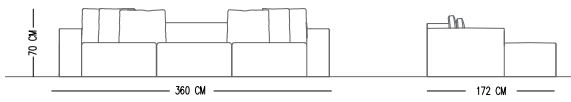

STANDARDS

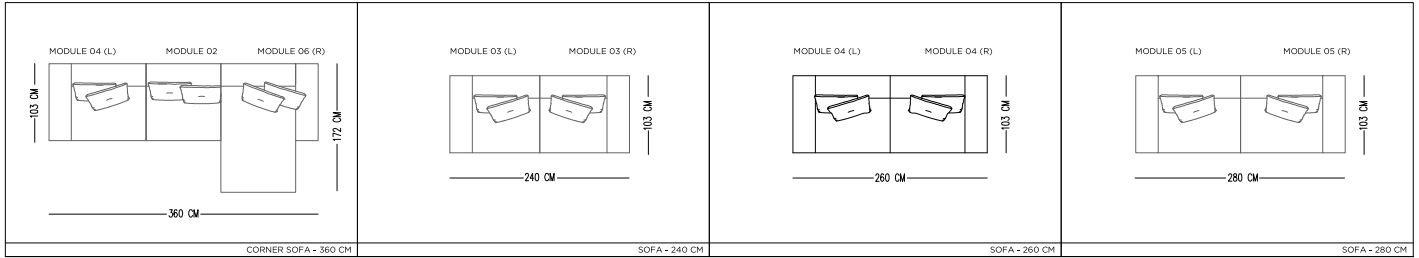

MODULES

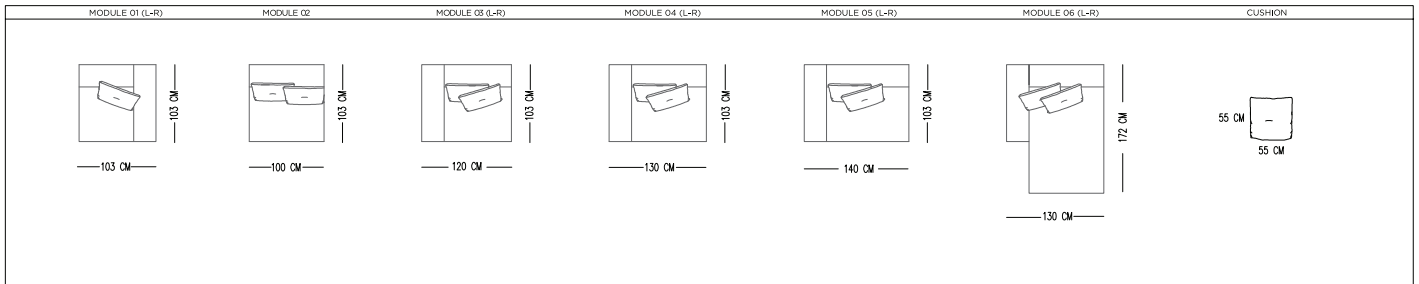

Catalog product-fabric

N-B11/Linen



2103

Alternative fabric
Linen, Boucle and Nubuck

Catalog product-Legs

Hidden Leg



RITA SOFA

TECHNICAL SPECIFICATIONS

INTERIOR STRUCTURE BEECH WOOD AND STEEL ZIGZAG BOW

SEAT CUSHION 35 DNS SOFT FOAM AND FIBER

BACK GOOSE DOWN AND FIBER MIX

UPHOLSTERY LOOSE

MAINTENANCE ALL DECORATIVE CUSHIONS ARE GOOSE DOWN AND SILICON MIX. QUANTITY AND DIMENSIONS ARE AS PER TECHNICAL DRAWINGS

We recommend shaking and fluffing-up the cushions regularly to maintain the shape. This should be done after removing the cushions from the structure for improved air circulation. For maintenance of fabric and leather, please contact your retailer.



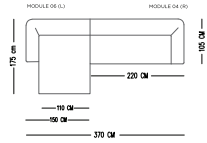
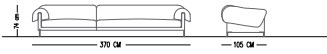
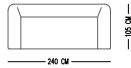

STANDARDS

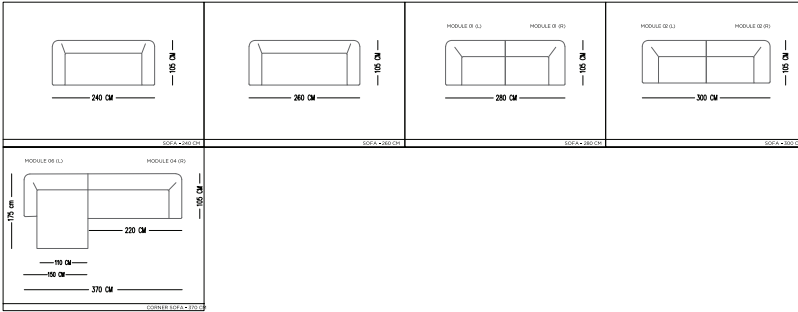

MODULES

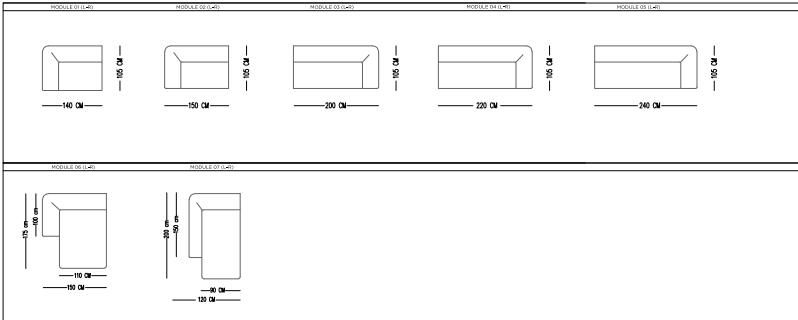

Catalog product-fabric

N-B28/Boucle



12

Catalog product-Legs

Electrostatic Powder Black Paint On Metal



Alternative fabric
Linen, Boucle and Linen teddy



ANGE SOFA

TECHNICAL SPECIFICATIONS

INTERIOR STRUCTURE BEECH WOOD AND ELASTIC COLUMN

SEAT CUSHION 35 DNS SOFT FOAM AND FIBER

BACK FIBER MIX

UPHOLSTERY TIGHT

MAINTENANCE ALL DECORATIVE CUSHIONS ARE GOOSE DOWN AND SILICON MIX, QUANTITY AND DIMENSIONS ARE AS PER TECHNICAL DRAWINGS. STANDART WITH 3 CUSHIONS 55*55, 3 CUSHIONS 45*45.

We recommend shaking and fluffing-up the cushions regularly to maintain the shape. This should be done after removing the cushions from the structure for improved air circulation. For maintenance of fabric and leather, please contact your retailer.



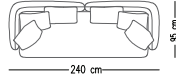
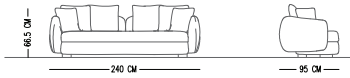
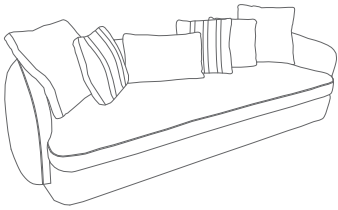

STANDARDS

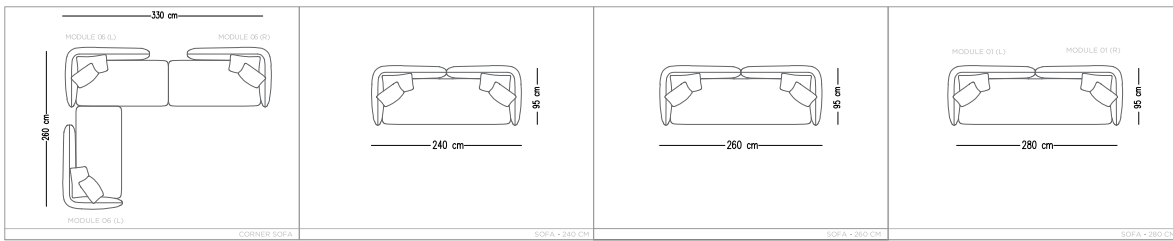

MODULES

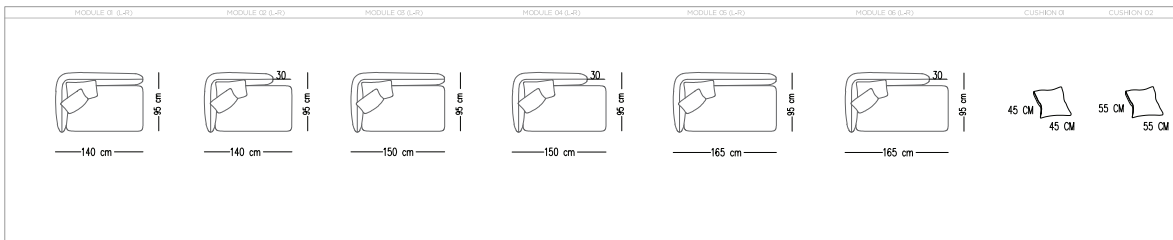

Catalog product-fabric

N-A20/Boucle



DLY 01

Alternative fabric
Linen, Linen teddy, Suede and Boucle

Catalog product-Legs

Black Painted Metal





CLEMENTINE SOFA

TECHNICAL SPECIFICATIONS

INTERIOR STRUCTURE SOLID WOOD AND ELASTIC COLUMN

SEAT CUSHION HIGH RESILIENT FOAM

BACK GOOSE DOWN & FIBER

UPHOLSTERY LOOSE

MAINTENANCE ALL DECORATIVE CUSHIONS ARE %100 GOOSE DOWN. QUANTITY AND DIMENSIONS ARE AS PER TECHNICAL DRAWING

We recommend shaking and fluffing-up the cushions regularly to maintain the shape. This should be done after removing the cushions from the structure for improved air circulation. For maintenance of fabric and leather, please contact your retailer.



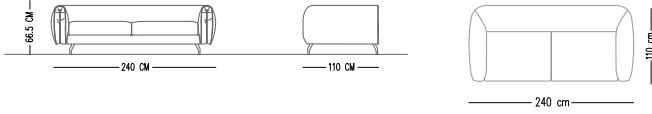
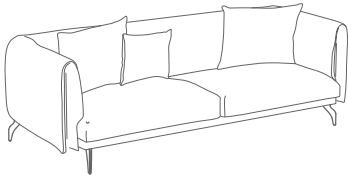

STANDARDS

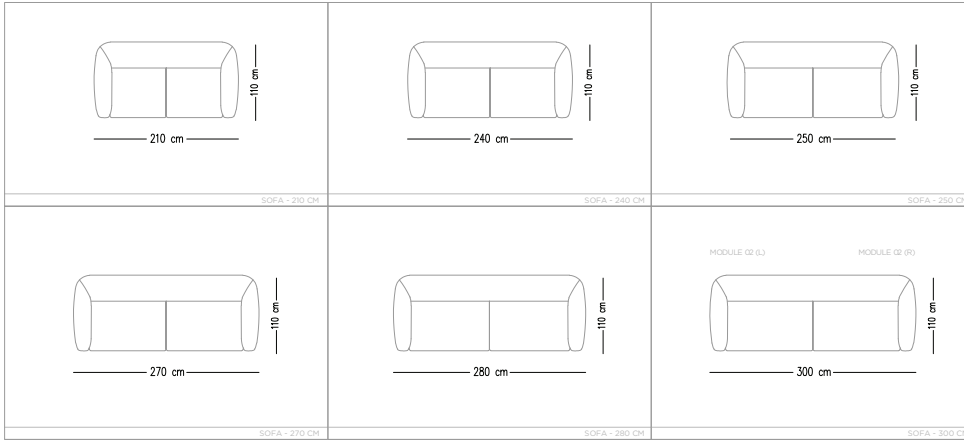

MODULES

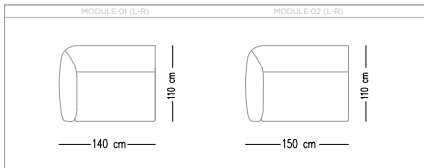

Catalog product-fabric

N-B33/Linen



11

Catalog product-Legs

Black Painted Metal



Alternative fabric
Linen, Boucle, Faux leather, Nubuck, and Linen teddy



OLIVER SOFA

TECHNICAL SPECIFICATIONS

INTERIOR STRUCTURE BEECH HARDWOOD FRAME AND ZIGZAG

SEAT CUSHION 35 DNS SOFT FOAM

BACK 35 DNS SOFT FOAM

LEGS HARDWOOD

MAINTENANCE STANDART WITH 0 CUSHIONS

We recommend shaking and fluffing-up the cushions regularly to maintain the shape.
This should be done after removing the cushions from the structure for improved air circulation.
For maintenance of fabric and leather, please contact your retailer



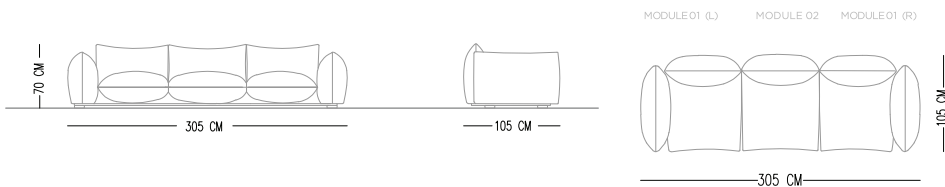
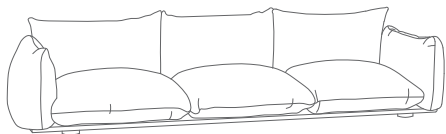

STANDARDS

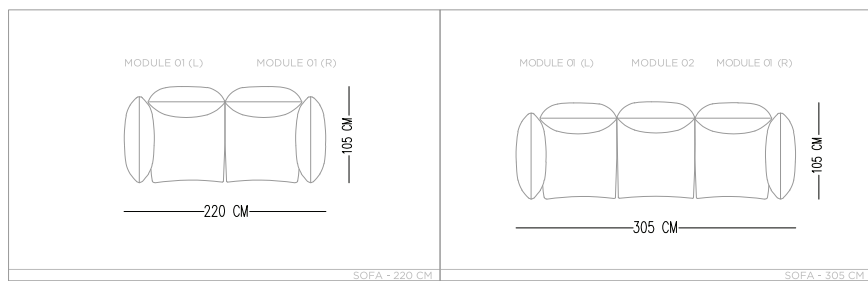

MODULES

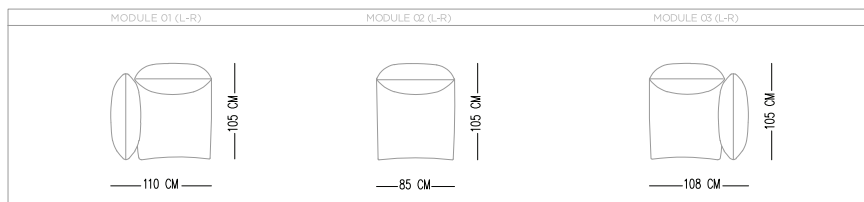

Catalog product-fabric

N-C21/Velvet



1007

Catalog product-Legs

Hidden Leg

Alternative fabric
Linen and Boucle



SOMET SOFA

TECHNICAL SPECIFICATIONS

INTERIOR STRUCTURE BEECH HARDWOOD FRAME AND STEEL ZIGZAG BOW

SEAT CUSHION 35 DNS SOFT FOAM

BACK 35 DNS SOFT FOAM

UPHOLSTERY TIGHT

MAINTENANCE STANDART WITH 2 CUSHIONS

We recommend shaking and fluffing-up the cushions regularly to maintain the shape. This should be done after removing the cushions from the structure for improved air circulation. For maintenance of fabric and leather, please contact your retailer.



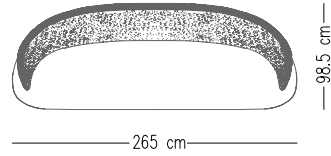
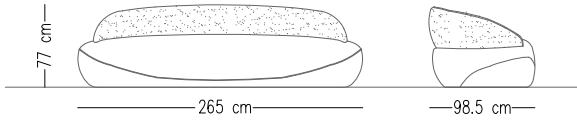
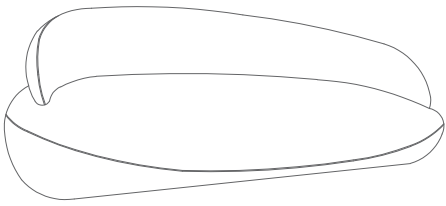

STANDARDS

MODULES

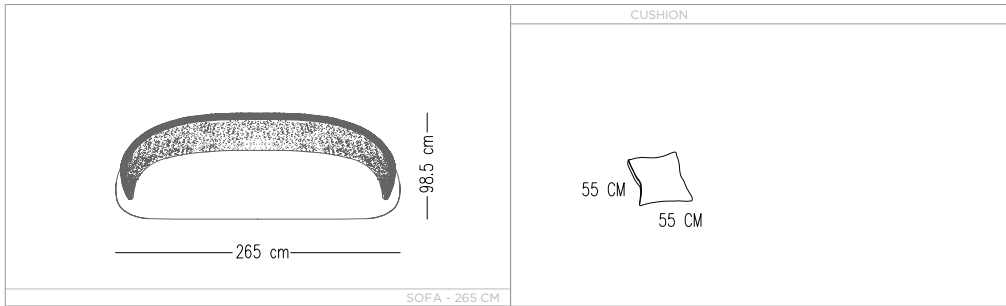

Catalog product-fabric

N-B27/Linen



01

Catalog product-Legs

Hidden Leg

Alternative fabric
Linen teddy, Boucle and Linen



LORA SOFA

TECHNICALS PECIFICATIONS

INTERIOR STRUCTURE BEECH HARDWOOD FRAME AND ZIGZAG BOW

SEAT CUSHION GOOSE DOWN AND FIBER

BACK GOOSE DOWN AND FIBER

UPHOLSTERY TIGHT

MAINTENANCE ALL DECORATIVE CUSHIONS ARE GOOSE DOWN AND SILICON MIX, QUANTITY AND DIMENSIONS ARE AS PER TECHNICAL DRAWINGS. STANDART WITH 2 CUSHIONS.

We recommend shaking and fluffing-up the cushions regularly to maintain the shape. This should be done after removing the cushions from the structure for improved air circulation. For maintenance of fabric and leather, please contact your retailer



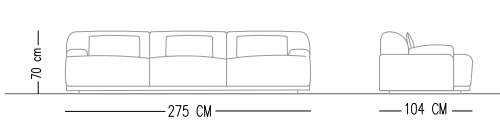
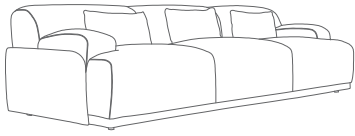

MODULE 01 (L) M MODULE 02 M MODULE 01 (R)

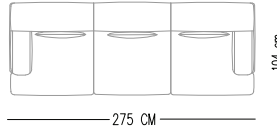

STANDARDS

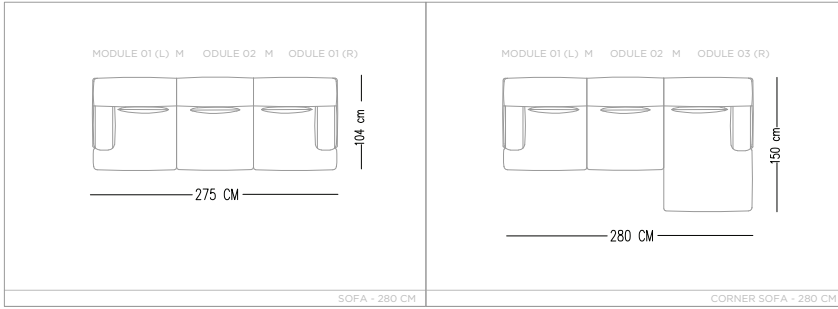

MODULES

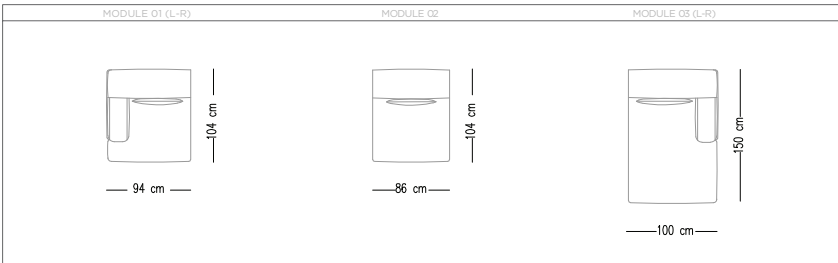

Catalog product-fabric

N-A34/Linen



65620

Alternative fabric
Linen and Boucle

Catalog product-Legs

Hidden Leg



HARLES SOFA

TECHNICAL SPECIFICATIONS

INTERIOR STRUCTURE BEECH HARDWOOD FRAME AND ELASTIC COLUMN

SEAT CUSHION 35 DNS SOFT FOAM

BACK GOOSE DOWN AND FIBER MIX

UPHOLSTERY TIGHT

MAINTENANCE ALL DECORATIVE CUSHIONS ARE GOOSE DOWN AND SILICON MIX, QUANTITY AND DIMENSIONS ARE AS PER TECHNICAL DRAWINGS, STANDART WITH 2 CUSHIONS 35*60

We recommend shaking and fluffing-up the cushions regularly to maintain the shape. This should be done after removing the cushions from the structure for improved air circulation. For maintenance of fabric and leather, please contact your retailer.



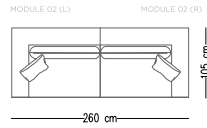
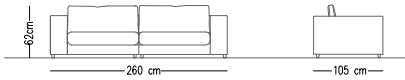
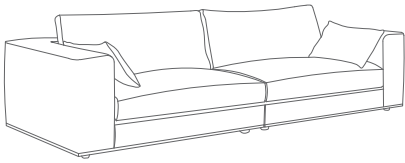

STANDARDS

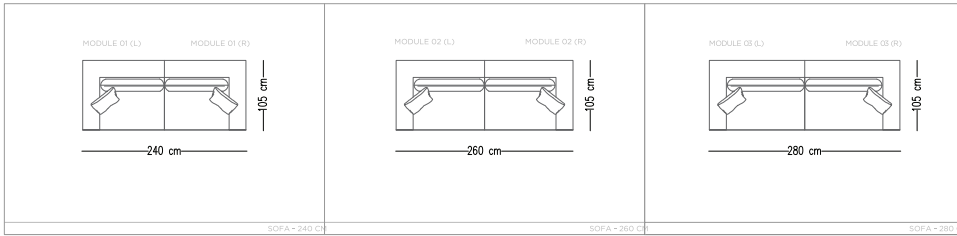

MODULES

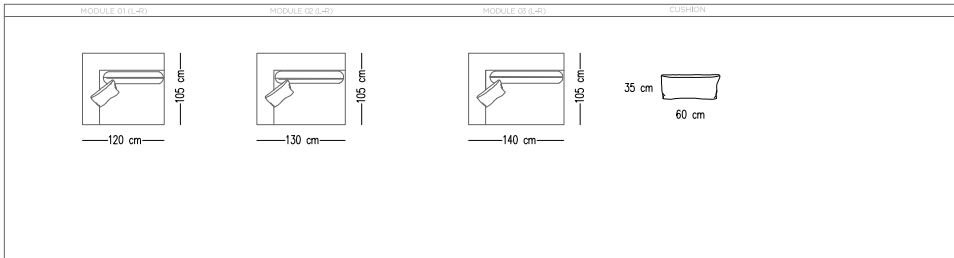

Catalog product-fabric

N-B27/Linen



01

Catalog product-Legs

Hidden Leg

Alternative fabric
Linen and Boucle



VENEDIK SOFA

TECHNICAL SPECIFICATIONS

INTERIOR STRUCTURE BEECH HARDWOOD FRAME AND ELASTIC COLUMN

SEAT CUSHION GOOSE DOWN AND FIBER MIX

BACK GOOSE DOWN AND FIBER MIX

UPHOLSTERY TIGHT

MAINTENANCE ALL DECORATIVE CUSHIONS ARE GOOSE DOWN AND SILICON MIX. QUANTITY AND DIMENSIONS ARE AS PER TECHNICAL DRAWINGS. STANDART WITH 2 CUSHIONS 45*45, 2 CUSHIONS 50*50 .

We recommend shaking and fluffing-up the cushions regularly to maintain the shape. This should be done after removing the cushions from the structure for improved air circulation, For maintenance of fabric and leather, please contact your retailer.



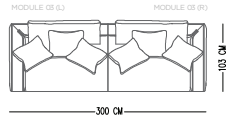
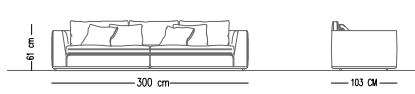
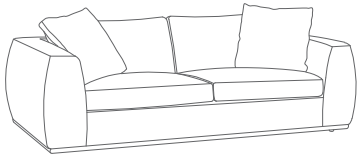

STANDARDS

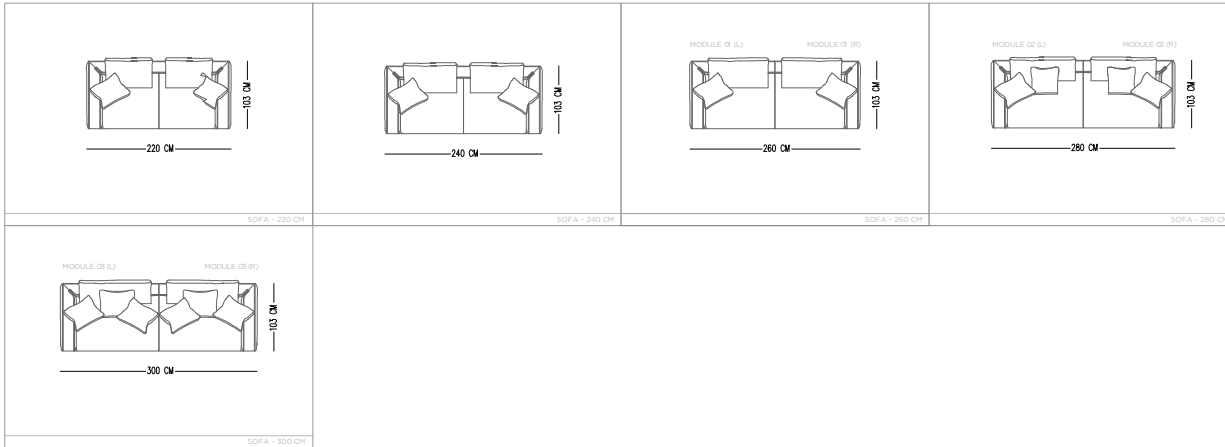

MODULES

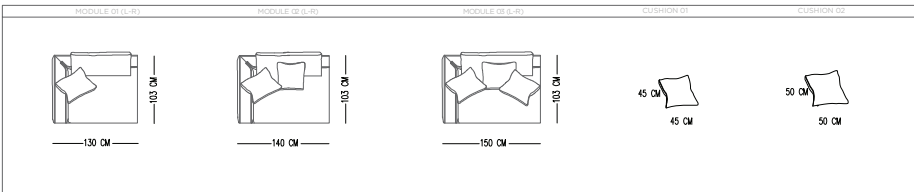

Catalog product-fabric

NA-10/Linen



43850

Alternative fabric
Linen, Boucle and Nubuck

Catalog product-Legs

Hidden Leg



BİLGİN SOFA

TECHNICAL SPECIFICATIONS

INTERIOR STRUCTURE BEECH HARDWOOD FRAME AND ELASTIC COLUMN

SEAT CUSHION 22 DNS GREY FOAM

BACK 22 DNS GREY FOAM

UPHOLSTERY TIGHT

MAINTENANCE ALL DECORATIVE CUSHIONS ARE GOOSE DOWN AND SILICON MIX, QUANTITY AND DIMENSIONS ARE AS PER TECHNICAL DRAWINGS. STANDART WITH 2 CUSHIONS 45*90.

We recommend shaking and fluffing-up the cushions regularly to maintain the shape. This should be done after removing the cushions from the structure for improved air circulation. For maintenance of fabric and leather, please contact your retailer.



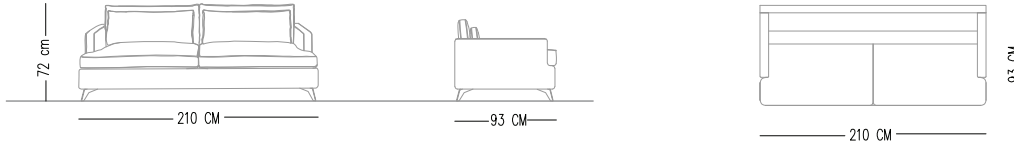
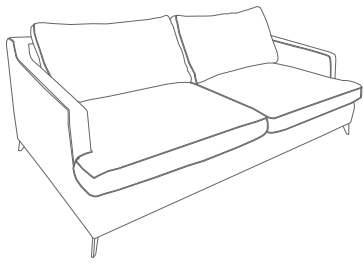

STANDARDS

MODULES

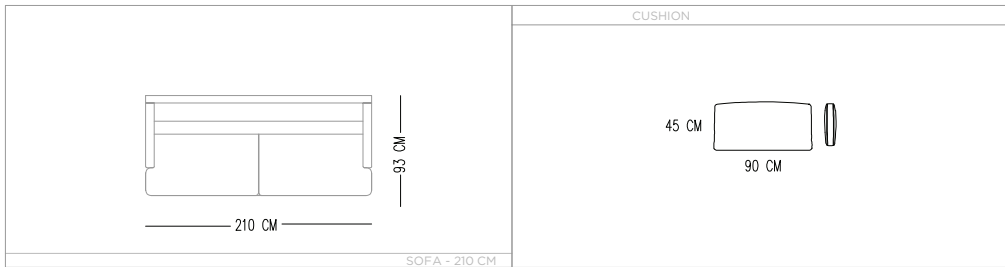

Catalog product-fabric

N-B34/Linen



08

Catalog product-Legs

Black Metal



Alternative fabric
Linen and Boucle



PIETRA SOFA

TECHNICAL SPECIFICATIONS

INTERIOR STRUCTURE FRAME BEECH AND ELASTIC COLUMN

SEAT CUSHION 35 DNS SOFT FOAM

BACK 28 DNS GREY FOAM

UPHOLSTERY TIGHT

MAINTENANCE ALL DECORATIVE CUSHIONS ARE GOOSE DOWN AND SILICON MIX. QUANTITY AND DIMENSIONS ARE AS PER TECHNICAL DRAWINGS. STANDART WITH 4 CUSHIONS 45*45, 3 CUSHIONS 35*50

We recommend shaking and fluffing-up the cushions regularly to maintain the shape. This should be done after removing the cushions from the structure for improved air circulation. For maintenance of fabric and leather, please contact your retailer.



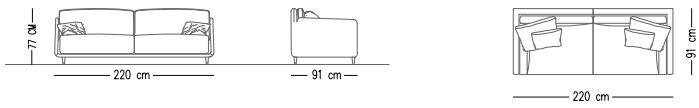

STANDARDS

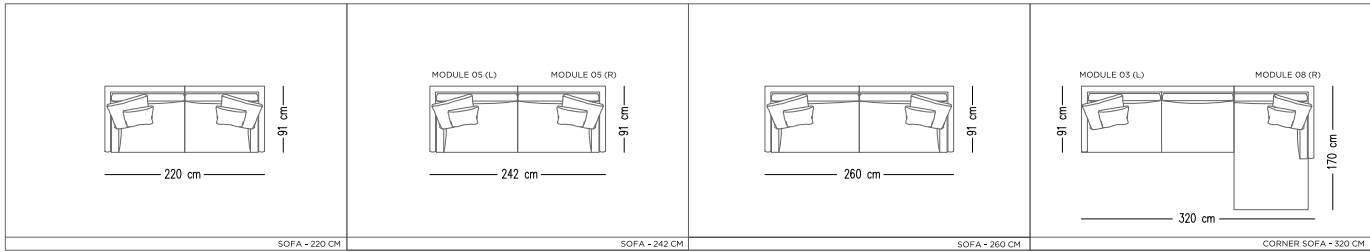

MODULES

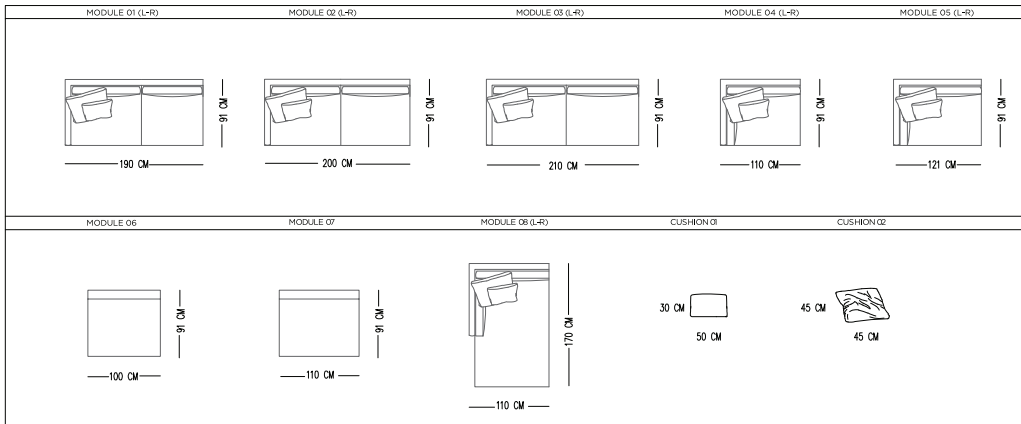

Catalog product-fabric

N-B13/Linen



A GRI - 01

Catalog product-Legs

Black wood and brass old detail



Alternative fabric
Linen and Boucle

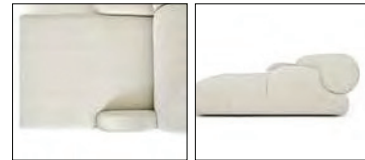

JUPITER SOFA

TECHNICAL SPECIFICATIONS

INTERIOR STRUCTURE BEECH HARDWOOD FRAME AND ZIGZAG BOW

SEAT CUSHION 35 DNS SOFT FOAM AND FIBER

BACK GOOSE DOWN AND FIBER

UPHOLSTERY TIGHT

MAINTENANCE ALL DECORATIVE CUSHIONS ARE GOOSE DOWN AND SILICON MIX. QUANTITY AND DIMENSIONS ARE AS PER TECHNICAL DRAWINGS. STANDART WITH 4 CUSHIONS

We recommend shaking and fluffing-up the cushions regularly to maintain the shape. This should be done after removing the cushions from the structure for improved air circulation. For maintenance of fabric and leather, please contact your retailer.



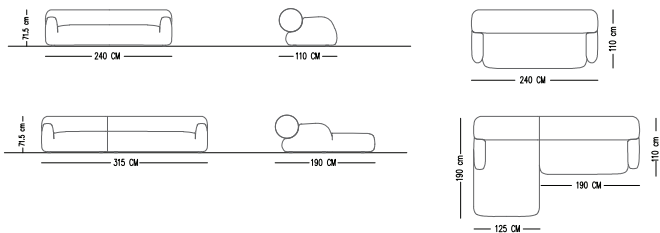

STANDARDS

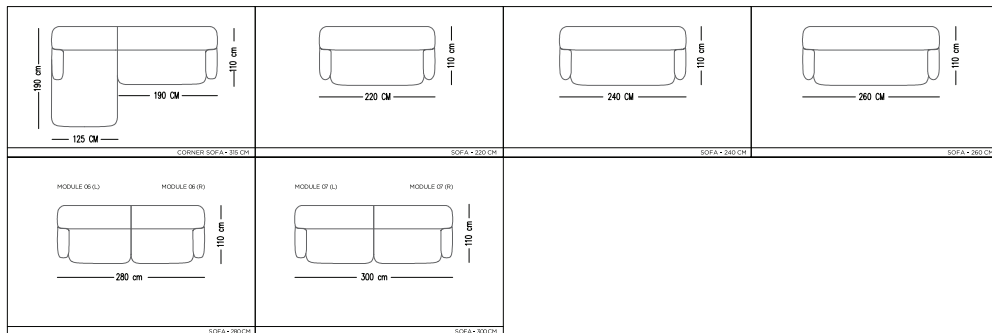

MODULES

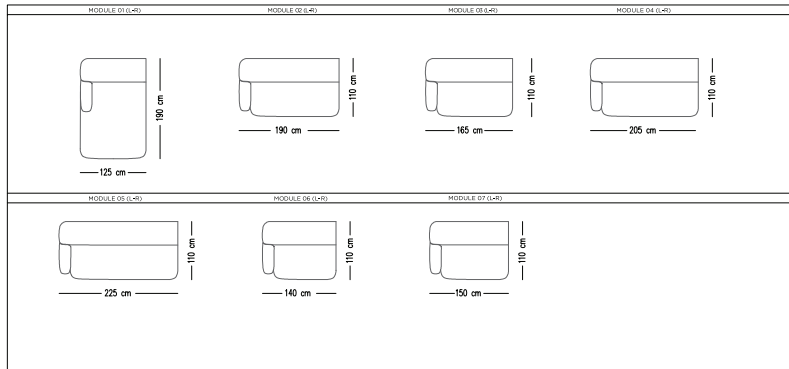

Catalog product-fabric

Catalog product-Legs

N-C35/ Linen teddy

Hidden leg



Laura

Alternative fabric
Linen, Boucle, Faux leather and Linen teddy



AUDREY SOFA

TECHNICAL SPECIFICATIONS

INTERIOR STRUCTURE BEECH HARDWOOD FRAME AND ZIGZAG BOW

SEAT CUSHION 35 DNS SOFT FOAM AND FIBER

BACK GOOSE DOWN AND FIBER

UPHOLSTERY TIGHT

LEGS ELECTROSTATIC POWDER BLACK PAINT ON METAL

MAINTENANCE ALL DECORATIVE CUSHIONS ARE GOOSE DOWN AND SILICON MIX, QUANTITY AND DIMENSIONS ARE AS PER TEC DRAWINGS, STANDART WITH 4 CUSHIONS

We recommend shaking and flufing-up the cushions regularly to maintain the shape.

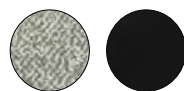

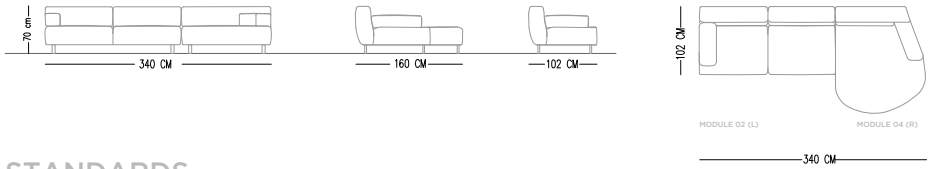
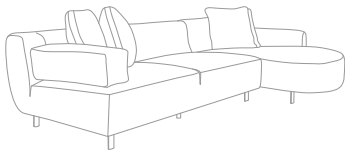

STANDARDS

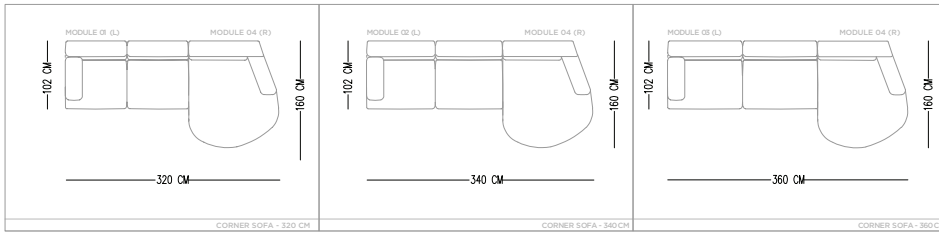

MODULES

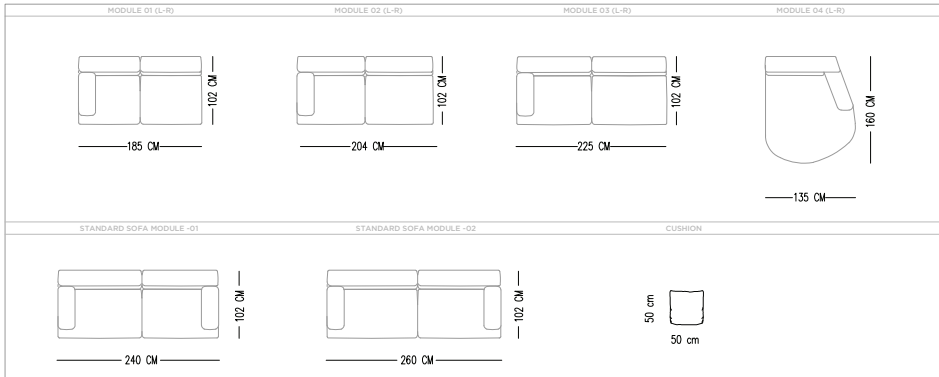

Catalog product-fabric

N-C41/Linen Velvet



5048

Alternative fabric
Linen, Boucle and Linen teddy

Catalog product-Legs

Electrostatic Powder Black Paint On Metal





DOMINO CORNER SOFA

TECHNICAL SPECIFICATIONS

INTERIOR STRUCTURE	BEECH HARDWOOD FRAME AND ZIGZAG BOW
SEAT CUSHION	GOOSE DOWN AND FIBER
CIRCULAR CUSIONS	GOOSE DOWN
UPHOLSTERY	TIGHT
MAINTENANCE	ALL DECORATIVE CUSHIONS ARE GOOSE DOWN AND SILICON MIX. QUANTITY AND DIMENSIONS ARE AS PER TECHNICAL DRAWINGS. We recommend shaking and fluffing-up the cushions regularly to maintain the shape. This should be done after removing the cushions from the structure for improved air circulation. For maintenance of fabric and leather, please contact your retailer



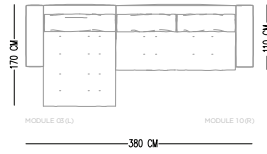
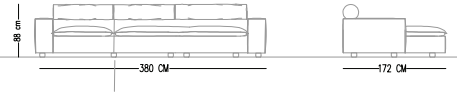
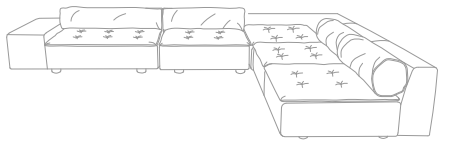

STANDARDS

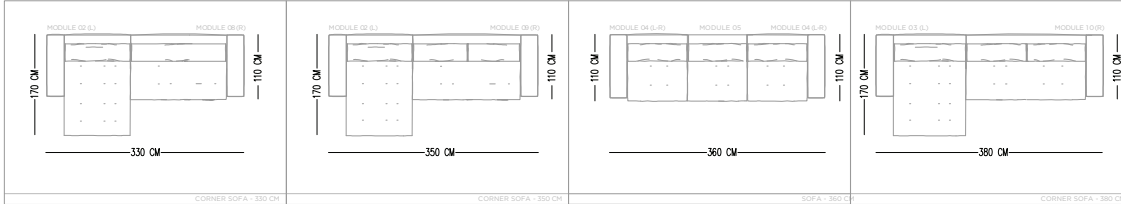

MODULES

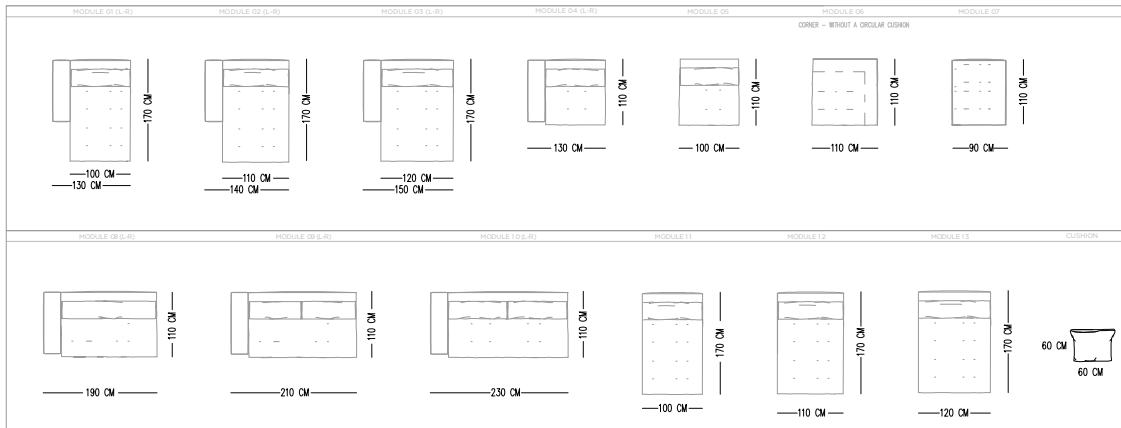

Catalog product-fabric

N-A17/Nubuck



048

Alternative fabric
Linen, Soft velvet and Nubuck

Catalog product-Legs

Hidden Leg



BULUT SOFA

TECHNICALS PECIFICATIONS

INTERIOR STRUCTURE BEECH WOOD AND STEEL AND MDF WITH ZIGZAG BOW

STRUCTURE PADDING 35 DNS SOFT FOAM ON PAD GOOSE DOWN

SEAT CUSHION GOOSE DOWN AND FIBER MIX

BACK BACK CUSHION 100% DOWN/FEATHERS

UPHOLSTERY LOOSE

MAINTENANCE ALL DECORATIVE CUSHIONS ARE GOOSE DOWN AND SILICON MIX, QUANTITY AND DIMENSIONS ARE AS PER TECHNICAL DRAWINGS. STANDART WITH 2 CUSHIONS 60*60, 2 CUSHIONS 45*45, 1 CUSHIONS 35*55.

We recommend shaking and fluffing-up the cushions regularly to maintain the shape.
This should be done after removing the cushions from the structure for improved air circulation.
For maintenance of fabric and leather, please contact your retailer



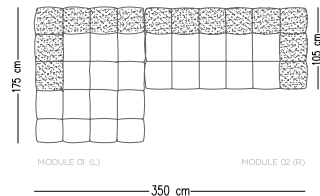
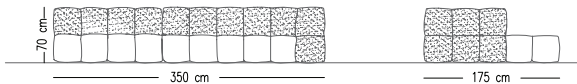

STANDARDS

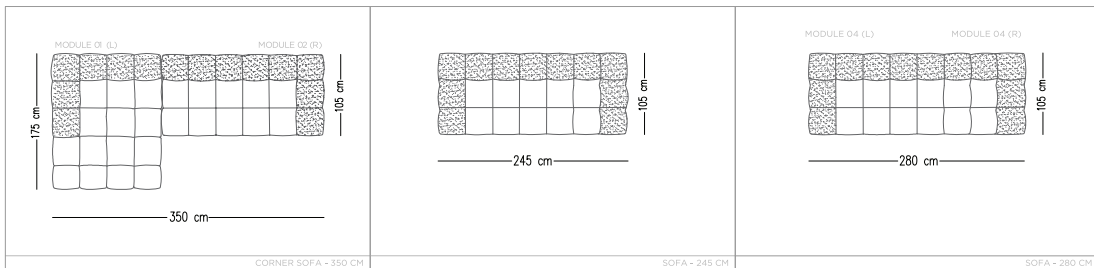

MODULES

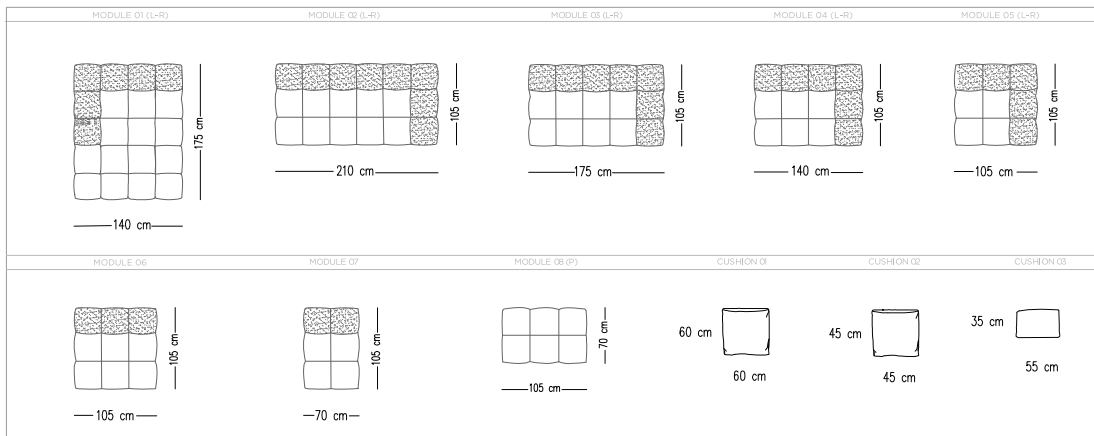

Catalog product-fabric

N-A16/Teddy



46860

Alternative fabric
Linen teddy, Suede, Linen and Boucle

Catalog product-Legs

Hidden Leg



NORA SOFA

TECHNICAL SPECIFICATIONS

INTERIOR STRUCTURE BEECH WOOD AND STEEL ZIGZAG BOW

SEAT CUSHION GOOSE DOWN AND FIBER MIX

BACK GOOSE DOWN AND FIBER MIX

UPHOLSTERY TIGHT

MAINTENANCE ALL DECORATIVE CUSHIONS ARE GOOSE DOWN AND SILICON MIX. QUANTITY AND DIMENSIONS ARE AS PER TECHNICAL DRAWINGS. STANDART WITH 6 CUSHIONS 55*55.

We recommend shaking and fluffing-up the cushions regularly to maintain the shape. This should be done after removing the cushions from the structure for improved air circulation. For maintenance of fabric and leather, please contact your retailer.



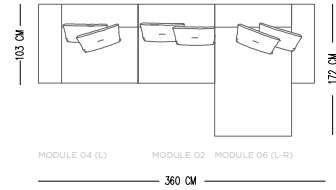
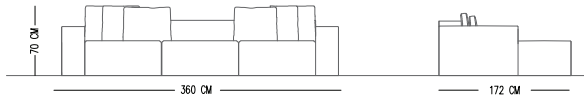
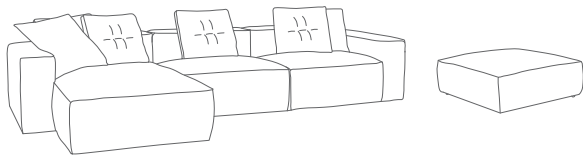

STANDARDS

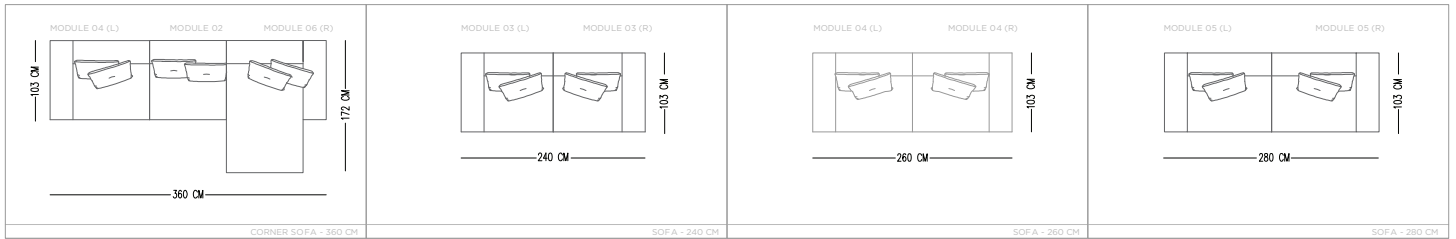

MODULES

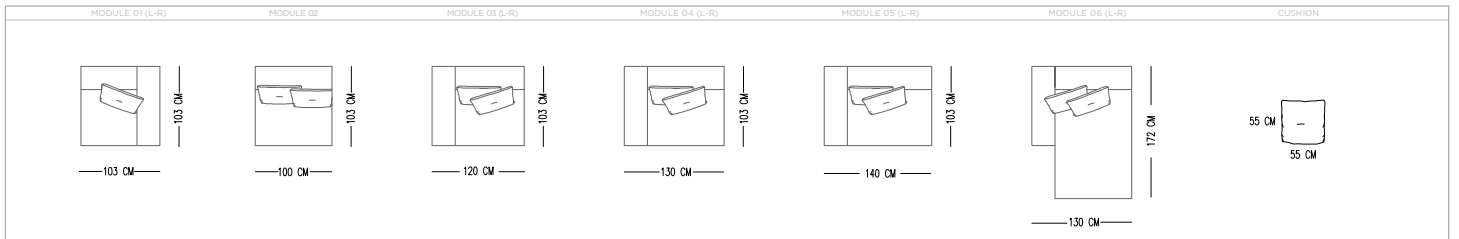

Catalog product-fabric

N-B13/Linen



Krem 02

Alternative fabric
Linen, Boucle and Nubuck

Catalog product-Legs

Hidden Leg



ITALS SOFA

TECHNICAL SPECIFICATIONS

INTERIOR STRUCTURE BEECH HARDWOOD FRAME AND ELASTIC COLUMN

SEAT CUSHION GOOSE DOWN AND FIBER MIX

BACK GOOSE DOWN AND FIBER MIX

UPHOLSTERY TIGHT

MAINTENANCE ALL DECORATIVE CUSHIONS ARE GOOSE DOWN AND SILICON MIX, QUANTITY AND DIMENSIONS ARE AS PER TECHNICAL DRAWINGS. STANDART WITH 3 CUSHIONS 25*55, 1 CUSHIONS 45*45

We recommend shaking and fluffing-up the cushions regularly to maintain the shape. This should be done after removing the cushions from the structure for improved air circulation, For maintenance of fabric and leather, please contact your retailer.



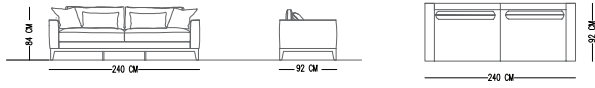

STANDARDS

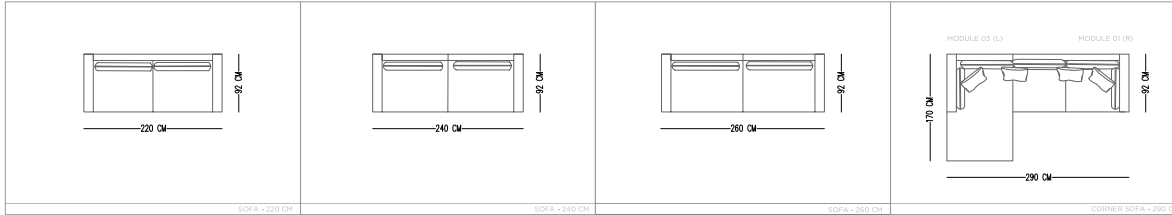

MODULES

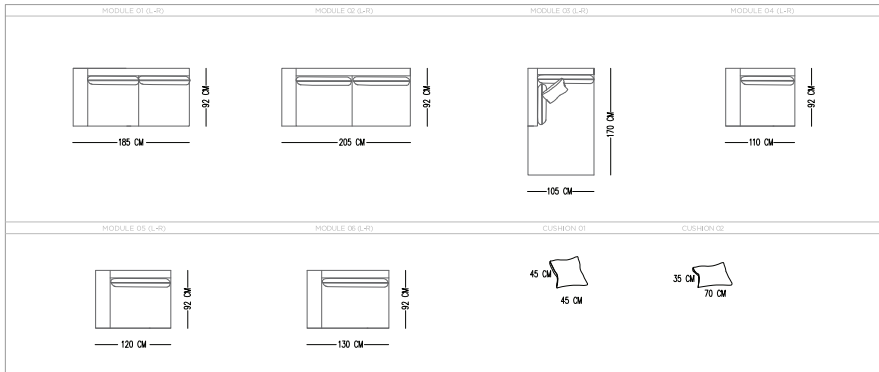

Catalog product-fabric

N-B32/Linen



213-05

Catalog product-Legs

Wooden walnut polish



Alternative fabric
Linen and Boucle



LEO SOFA

TECHNICALS PECIFICATIONS

INTERIOR STRUCTURE	BEECH HARDWOOD FRAME , ZIGZAG BOW AND ELASTIC COLUMN
SEAT CUSHION	22 DNS GREY FOAM
BACK	22 DNS GREY FOAM
UPHOLSTERY	TIGHT
MAINTENANCE	ALL DECORATIVE CUSHIONS ARE GOOSE DOWN AND SILICON MIX. QUANTITY AND DIMENSIONS ARE AS PER TECHNICAL DRAWINGS.STANDART WITH 3 CUSHIONS 70*70 We recommend shaking and fluffing-up the cushions regularly to maintain the shape. This should be done after removing the cushions from the structure for improved air circulation. For maintenance of fabric and leather, please contact your retailer.



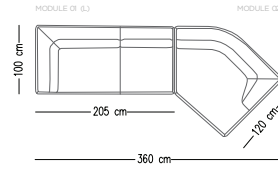
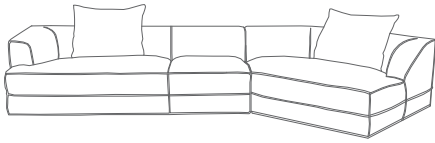

STANDARDS

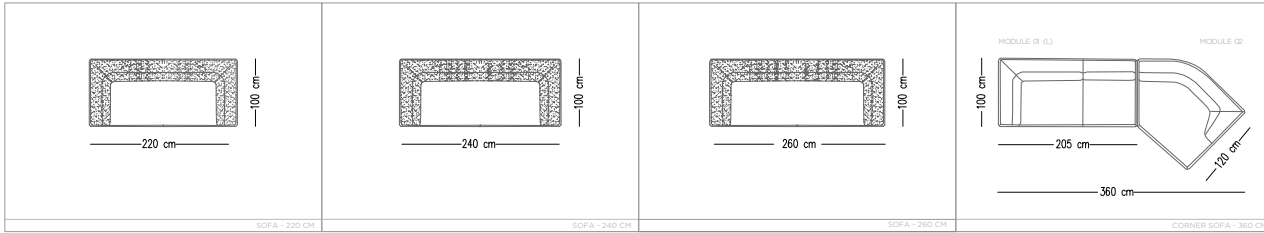

MODULES

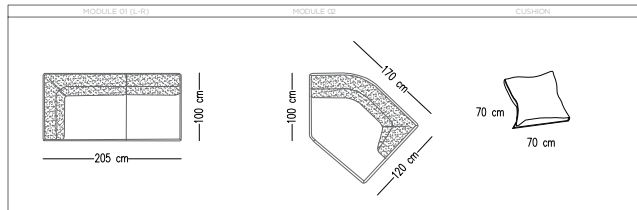

Catalog product-fabric

N-C14/Linen



7002

Alternative fabric
Linen

Catalog product-Legs

Hidden Leg



PORTO SOFA

TECHNICAL SPECIFICATIONS

INTERIOR STRUCTURE BEECH HARDWOOD FRAME AND ELASTIC COLUMN

SEAT CUSHION GOOSE DOWN AND FIBER MIX

BACK GOOSE DOWN AND FIBER MIX

UPHOLSTERY TIGHT

MAINTENANCE ALL DECORATIVE CUSHIONS ARE GOOSE DOWN AND SILICON MIX. QUANTITY AND DIMENSIONS ARE AS PER TECHNICAL DRAWINGS, STANDART WITH 4 CUSHIONS 60*60

We recommend shaking and fluffing-up the cushions regularly to maintain the shape. This should be done after removing the cushions from the structure for improved air circulation. For maintenance of fabric and leather, please contact your retailer.



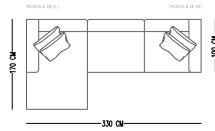
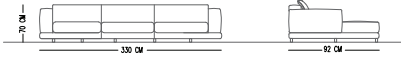

STANDARDS

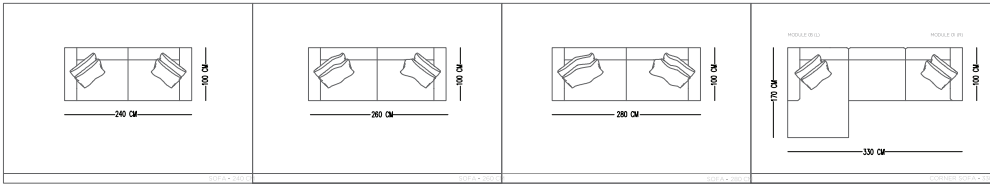

MODULES

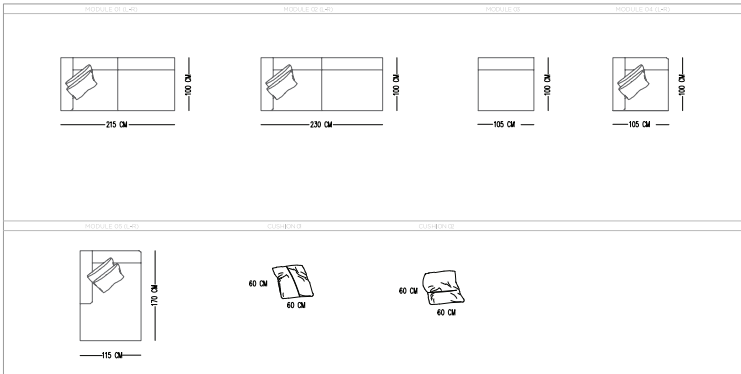

Catalog product-fabric

N-B39/Linen



2134

Catalog product-Legs

Black Painted Metal



Alternative fabric
Linen and Boucle



NIRVANA SOFA

TECHNICALS PECIFICATIONS

INTERIOR STRUCTURE	FRAME BEECH CONTRA AND ELASTIC COLUMN
SEAT CUSHION	35 DNS SOFT FOAM
BACK	22 DNS GREY FOAM
UPHOLSTERY	TIGHT
MAINTENANCE	<p>ALL DECORATIVE CUSHIONS ARE GOOSE DOWN AND SILICON MIX. QUANTITY AND DIMENSIONS ARE AS PER TECHNICAL DRAWINGS. STANDART WITH 4 CUSHIONS 50*50, 5 CUSHIONS 50*70</p> <p>We recommend shaking and fluffing-up the cushions regularly to maintain the shape. This should be done after removing the cushions from the structure for improved air circulation. For maintenance of fabric and leather, please contact your retailer .</p>

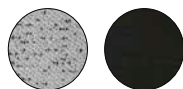

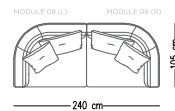
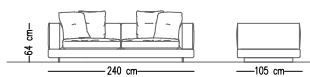
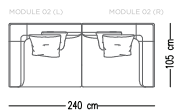
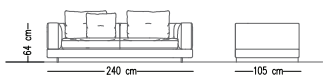

STANDARDS

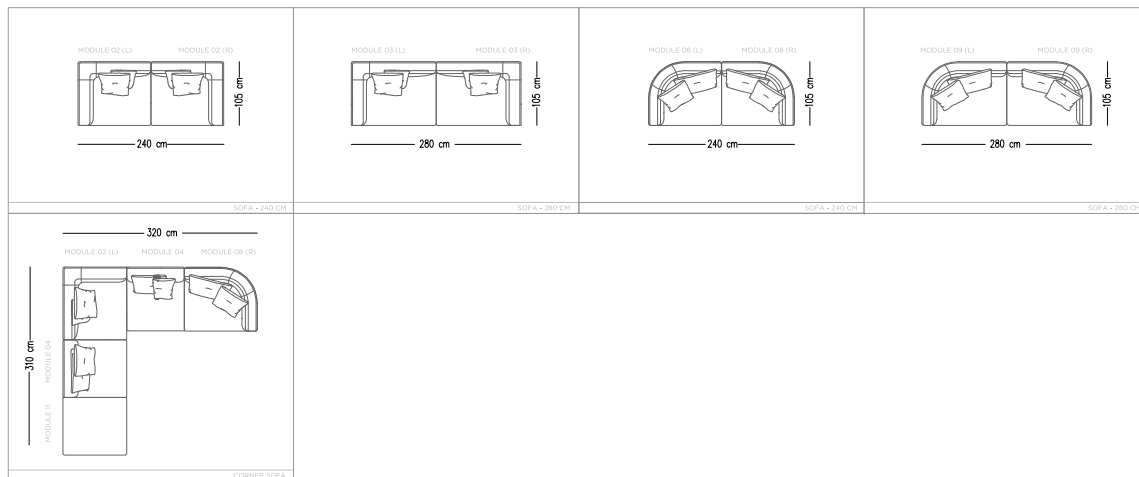

MODULES

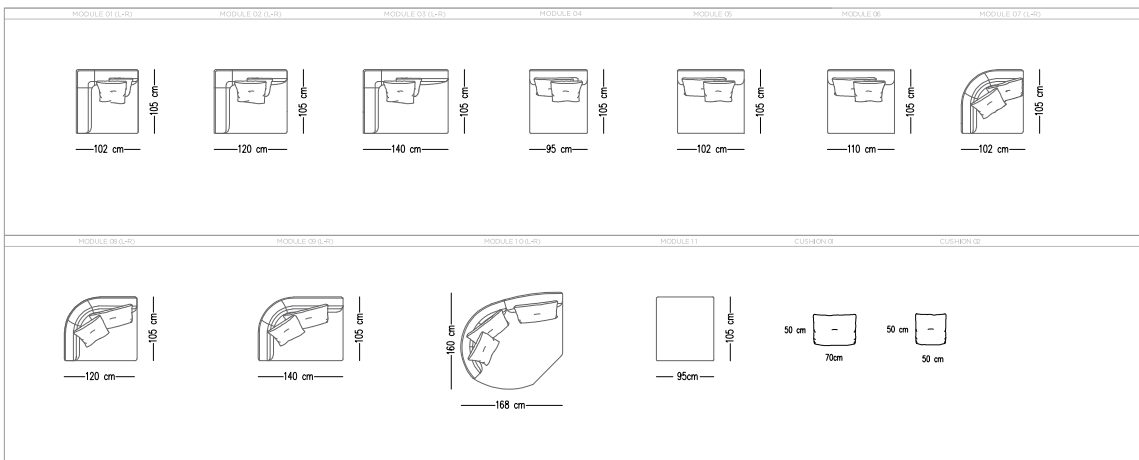

Catalog product-fabric

N-A26/Linen



112

Alternative fabric
Linen, Boucle and Chenille

Catalog product-Legs

Wood wenge varnish





RITA SOFA

TECHNICAL SPECIFICATIONS

INTERIOR STRUCTURE BEECH HARDWOOD FRAME AND ZIGZAG BOW

SEAT CUSHION 35 DNS SOFT FOAM AND FIBER

BACK GOOSE DOWN AND FIBER

UPHOLSTERY TIGHT

MAINTENANCE ALL DECORATIVE CUSHIONS ARE GOOSE DOWN AND SILICON MIX, QUANTITY AND DIMENSIONS ARE AS PER TECHNICAL DRAWINGS..STANDART WITH 4 CUSHIONS

We recommend shaking and fluffing-up the cushions regularly to maintain the shape. This should be done after removing the cushions from the structure for improved air circulation. For maintenance of fabric and leather, please contact your retailer.



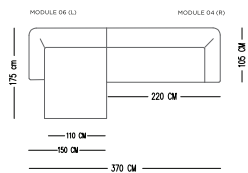
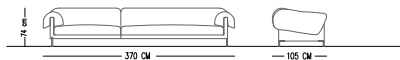
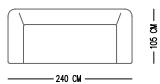
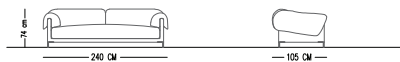

STANDARDS

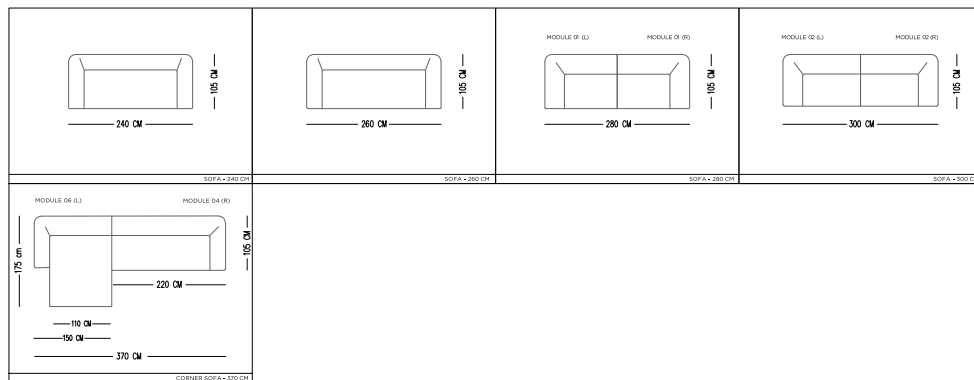

MODULES

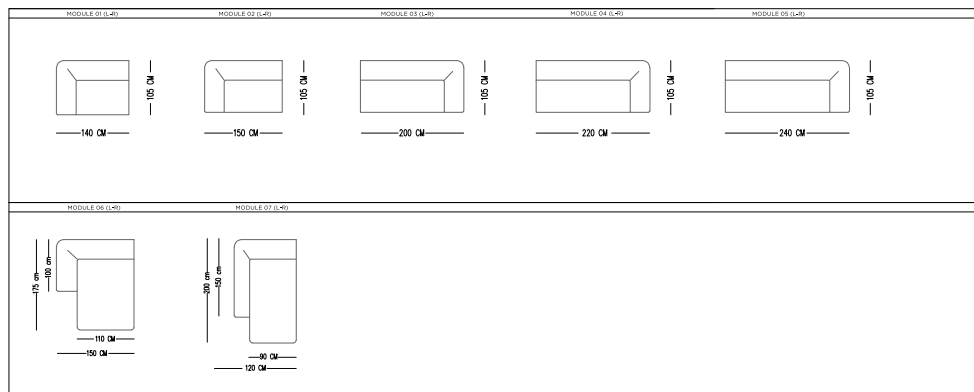

Catalog product-fabric

N-B11/Linen



2103

Catalog product-Legs

Electrostatic Powder Black Paint On Metal



Alternative fabric
Linen, Boucle and Linen teddy



ANGE SOFA

TECHNICAL SPECIFICATIONS

INTERIOR STRUCTURE BEECH WOOD AND ELASTIC COLUMN

SEAT CUSHION 35 DNS SOFT FOAM AND FIBER

BACK FIBER MIX

UPHOLSTERY TIGHT

MAINTENANCE ALL DECORATIVE CUSHIONS ARE GOOSE DOWN AND SILICON MIX, QUANTITY AND DIMENSIONS ARE AS PER TECHNICAL DRAWINGS. STANDART WITH 3 CUSHIONS 55*55, 3 CUSHIONS 45*45.

We recommend shaking and fluffing-up the cushions regularly to maintain the shape. This should be done after removing the cushions from the structure for improved air circulation. For maintenance of fabric and leather, please contact your retailer.



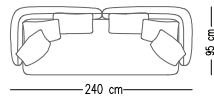
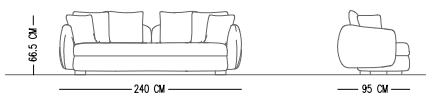

STANDARDS

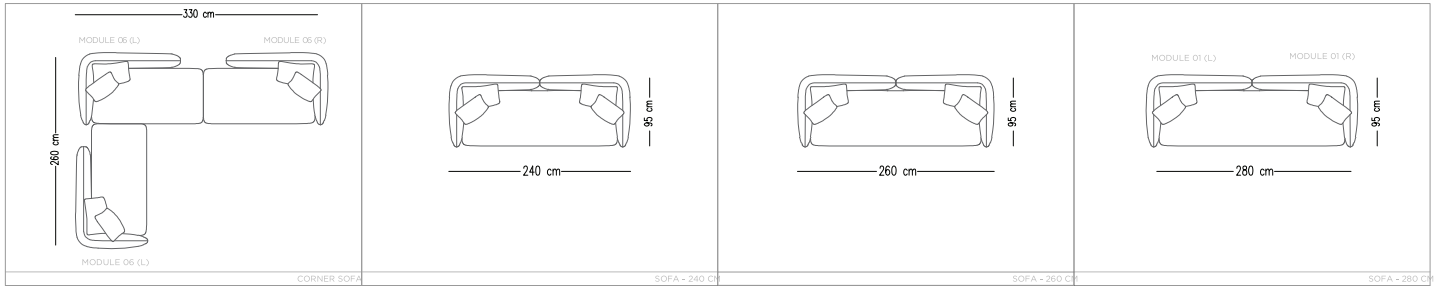

MODULES

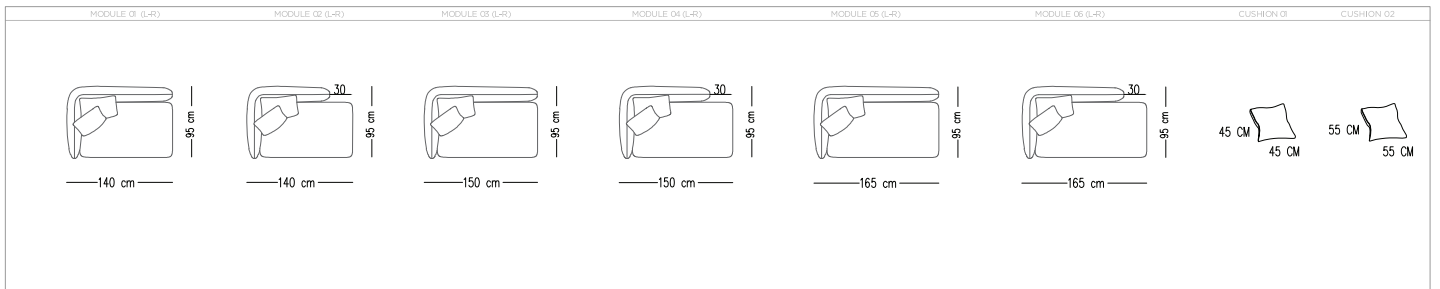

Catalog product-fabric

N-A11/Boucle



53323

Catalog product-Legs

Black Painted Metal



Alternative fabric
Linen, Linen teddy, Suede and Boucle



PIETRA SOFA

TECHNICAL SPECIFICATIONS

INTERIOR STRUCTURE FRAME BEECH AND ELASTIC COLUMN

SEAT CUSHION 28 DNS GREY FOAM

BACK GOOSE DOWN AND FIBER MIX

UPHOLSTERY TIGHT

MAINTENANCE ALL DECORATIVE CUSHIONS ARE GOOSE DOWN AND SILICON MIX. QUANTITY AND DIMENSIONS ARE AS PER TECHNICAL DRAWINGS. STANDART WITH 4 CUSHIONS 45*45, 3 CUSHIONS 35*50

We recommend shaking and fluffing-up the cushions regularly to maintain the shape. This should be done after removing the cushions from the structure for improved air circulation. For maintenance of fabric and leather, please contact your retailer.



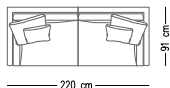
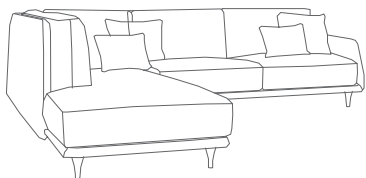

STANDARDS

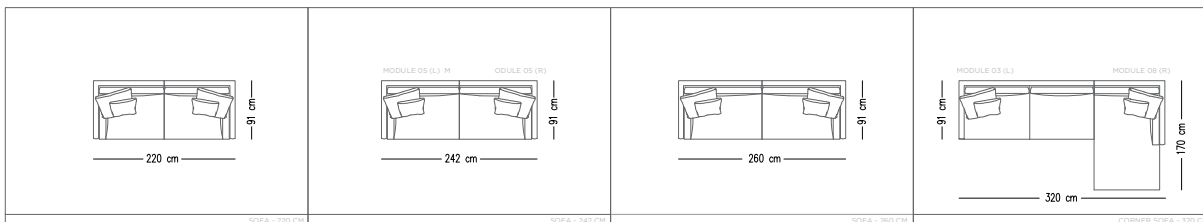

MODULES

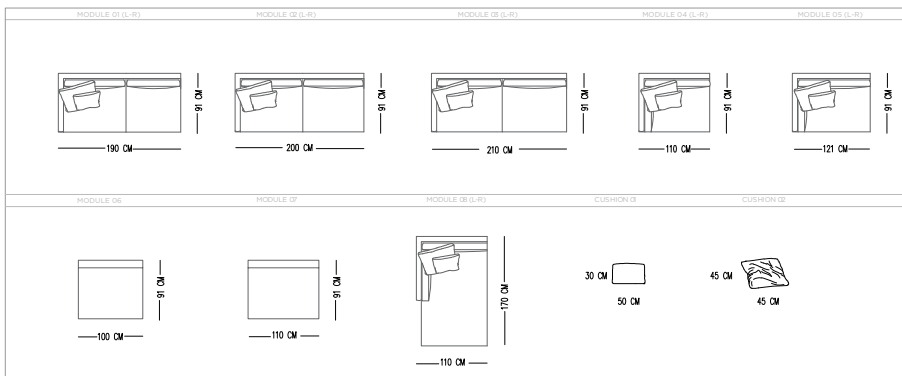

Catalog product-fabric

N-B32/Linen



213-13

Catalog product-Legs

Wood black and brass old detail



Alternative fabric
Linen and Boucle

STRONG PERSONALITY
AND GREAT COMFORT







YUI ARMCHAIR

TECHNICAL SPECIFICATIONS

INTERIOR STRUCTURE SOLID WOOD & PAPEL AND ELASTIC COLUMN

SEAT CUSHION HIGH RESILIENT FOAM

BACK GOOSE DOWN AND FIBER

UPHOLSTERY LEATHER / FABRIC (TIGHT)



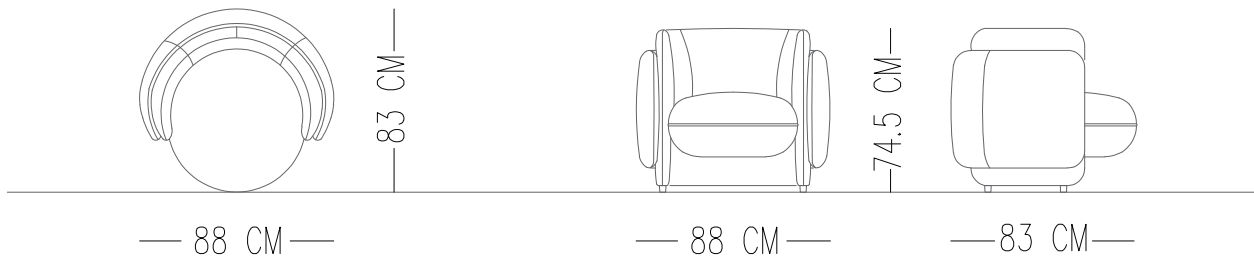

Catalog product-fabric

N-B45/Nubuck



501

Alternative fabric
Linen, Boucle, Faux leather and Linen teddy

Catalog product-Legs

Hidden leg



TOM ARMCHAIR

TECHNICAL SPECIFICATIONS

INTERIOR STRUCTURE

METAL STRUCTURE WITH CHROMIUM POLISH

SEAT CUSHION

COWHIDE LEATHER

UPHOLSTERY

COWHIDE LEATHER



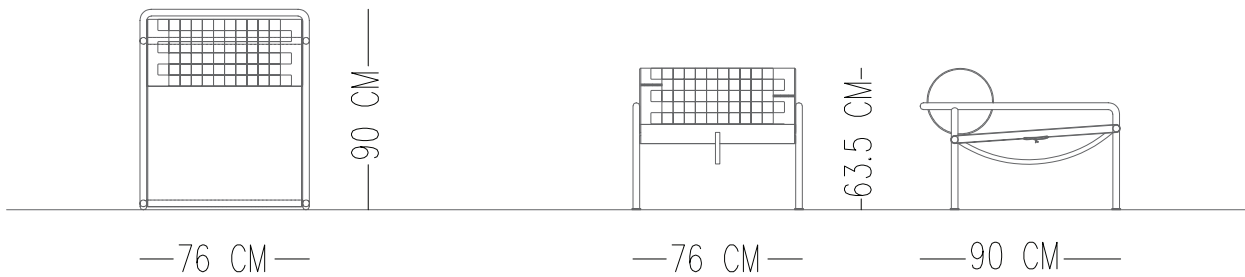

Catalog product-fabric

N-A36/Leather



806380

Catalog product-Legs

Chromium



Alternative fabric
Fabrics only N-A36 are available for this model



VIBE ARMCHAIR

TECHNICAL SPECIFICATIONS

INTERIOR STRUCTURE SOLID WOOD AND ELASTIC COLUMN

SEAT CUSHION HIGH RESILIENT FOAM

BACK GOOSE DOWN AND FIBER

UPHOLSTERY TIGHT



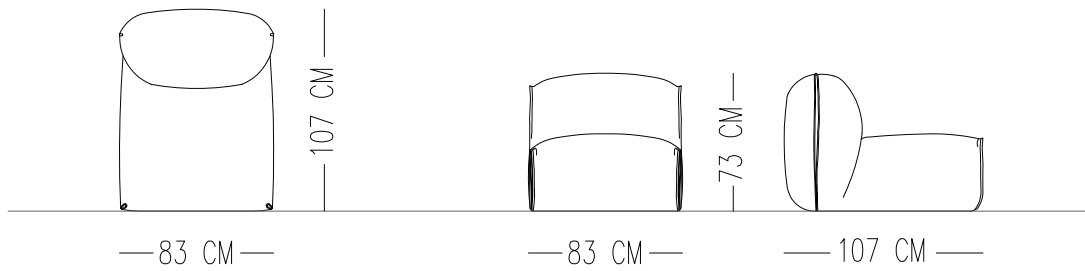

Catalog product-fabric

N-A40/Linen



Nata

Alternative fabric
Linen, Curl and Plush Linen

Catalog product-Legs

Hidden leg

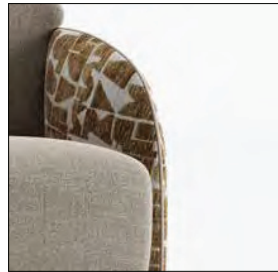

LOTUS ARMCHAIR

TECHNICAL SPECIFICATIONS

INTERIOR STRUCTURE BEECH HARDWOOD FRAME AND ZIGZAG BOW

SEAT CUSHION 35 DNS SOFT FOAM AND FIBER

BACK GOOSE DOWN AND FIBER

UPHOLSTERY TIGHT

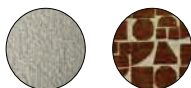

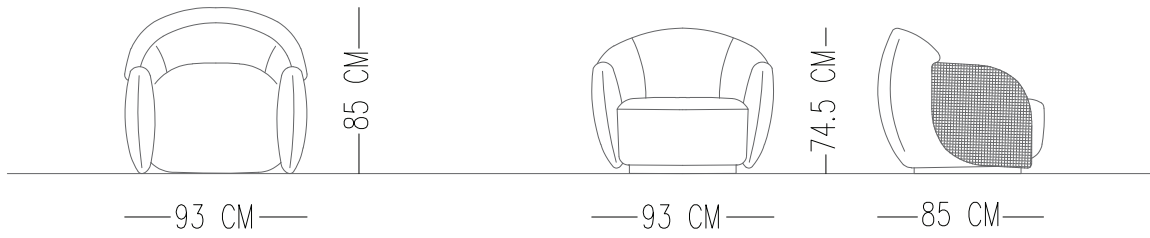

Catalog product-fabric

N-B29/Linen



01

N-C50/Linen



3049

Alternative fabric
 Boucle, Linen, Faux Leather, Nubuck, Suede, Figured
 Linen, Linen Teddy

Catalog product-Legs

Hidden leg



PRIMA ARMCHAIR

TECHNICAL SPECIFICATIONS

STRUCTURE

TEAK WOOD BLACK FINISHES



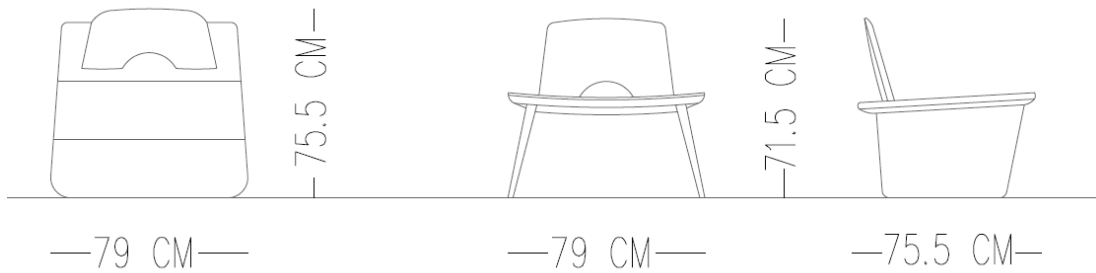

Catalog product-fabric

Teak wood



Transparent black finishes

Alternative material

Teak wood natural teak color varnish



MONA ARMCHAIR

TECHNICAL SPECIFICATIONS

INTERIOR STRUCTURE SOLID WOOD & PAPEL AND ELASTIC COLUMN

SEAT CUSHION HIGH RESILIENT FOAM

BACK GOOSE DOWN & FIBER

UPHOLSTERY LEATHER / FABRIC (TIGHT)



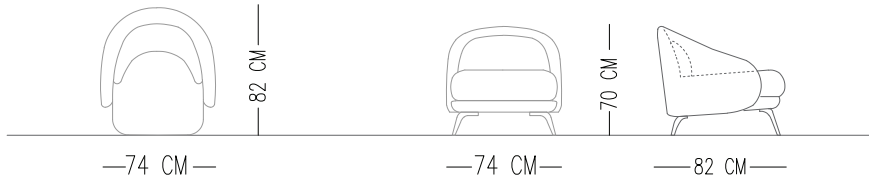
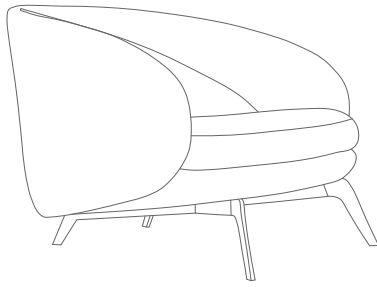

Catalog product-fabric

N-B39/Linen



2134

Leather



43497

Alternative fabric
Linen&Faux leather,Linen&Leather
Linen,Faux leather and Leather

Catalog product-Legs

Black painted metal leg





RITA ARMCHAIR

TECHNICAL SPECIFICATIONS

INTERIOR STRUCTURE SOLID WOOD AND ZIGZAG BOW

SEAT CUSHION GOOSE DOWN & FIBER

BACK GOOSE DOWN AND FIBER

UPHOLSTERY LOOSE



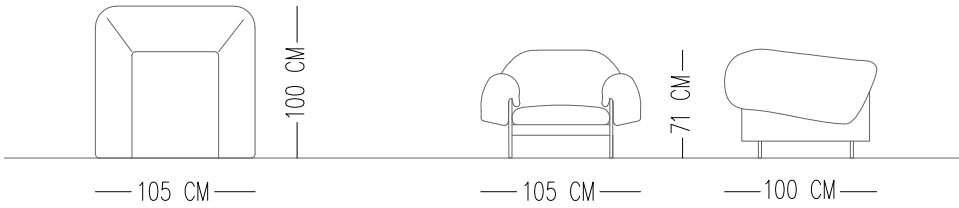
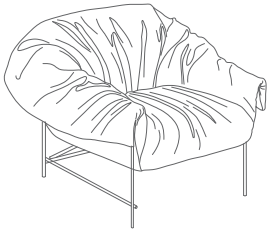

Catalog product-fabric

N-B28/Boucle



15

Alternative fabric
Linen, Boucle and Linen teddy

Catalog product-Legs

Black Painted Metal Legs





LORA ARMCHAIR

TECHNICAL SPECIFICATIONS

INTERIOR STRUCTURE	SOLID WOOD AND ELASTIC COLUMN
SEAT CUSHION	HIGH RESILIENT FOAM
BACK	GOOSE DOWN & FIBER
UPHOLSTERY	TIGHT
MAINTENANCE	We recommend shaking and fluffing-up the cushions regularly to maintain the shape. This should be done after removing the cushions from the structure for improved air circulation. For maintenance of fabric and leather, please contact your retailer.



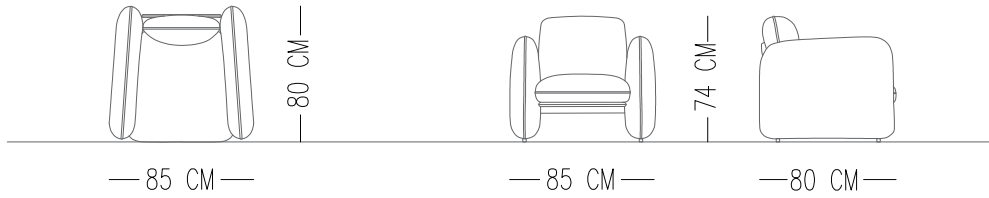
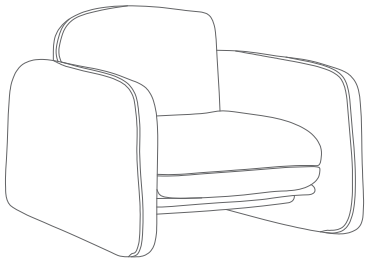

Catalog product-fabric

N-B19/Linen



03

Alternative fabric
Boucle,Linen and Linen teddy

Catalog product-Legs

Hidden Leg



AUDREY ARMCHAIR

TECHNICAL SPECIFICATIONS

INTERIOR STRUCTURE SOLID WOOD & PAPEL AND ZIGZAG BOW

SEAT CUSHION HIGH RESILIENT FOAM

BACK CUSHION 100% DOWN/FEATHERS

UPHOLSTERY TIGHT

MAINTENANCE We recommend shaking and fluffing-up the cushions regularly to maintain the shape. This should be done after removing the cushions from the structure for improved air circulation. For maintenance of fabric and leather, please contact your retailer.



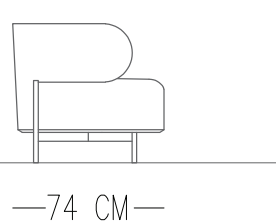
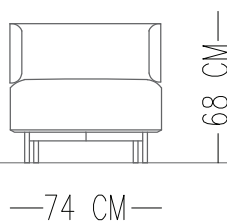
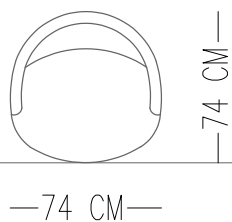
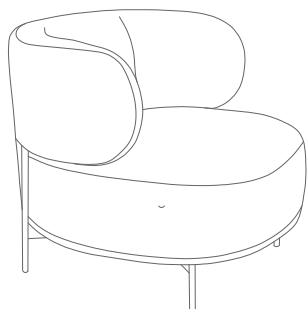

Catalog product-fabric

N-B22/Linen



01

Alternative fabric
Boucle,Linen and Linen teddy

Catalog product-Legs

Black painted metal leg





CLEMENTINE ARMCHAIR

TECHNICAL SPECIFICATIONS

INTERIOR STRUCTURE SOLID WOOD AND ELASTIC COLUMN

SEAT CUSHION HIGH RESILIENT FOAM

BACK GOOSE DOWN AND FIBER

UPHOLSTERY LOOSE

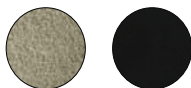

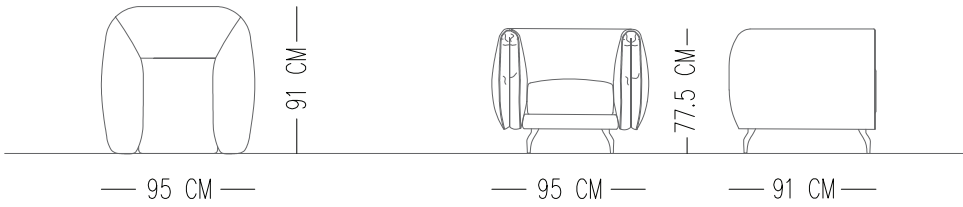
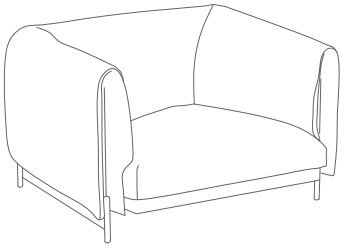

Catalog product-fabric

N-C18/Boucle



22297-20

Alternative fabric

Linen, Boucle, Faux leather, Nubuck, and Linen teddy

Catalog product-Legs

Black Painted Metal Legs





OLIVER ARMCHAIR

TECHNICAL SPECIFICATIONS

INTERIOR STRUCTURE	BEECH HARDWOOD FRAME AND ELASTIC COLUMN
SEAT CUSHION	HIGH RESILIENT FOAM
BACK	GOOSE DOWN & FIBER
UPHOLSTERY	TIGHT
MAINTENANCE	ALL DECORATIVE CUSHIONS ARE %100 GOOSE DOWN, QUANTITY AND DIMENSIONS ARE AS PER TECHNICAL DRAWING We recommend shaking and fluffing-up the cushions regularly to maintain the shape. This should be done after removing the cushions from the structure for improved air circulation. For maintenance of fabric and leather, please contact your retailer

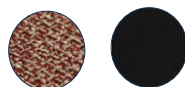

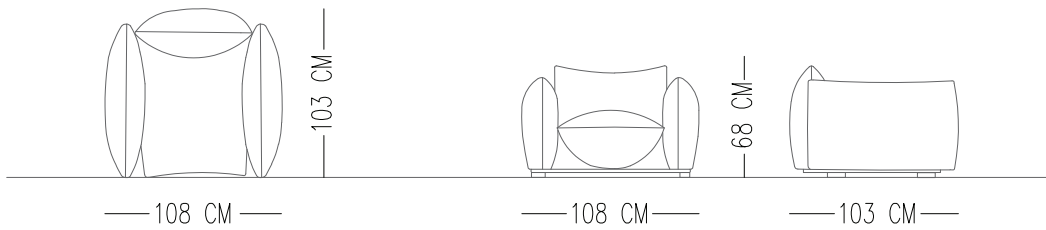
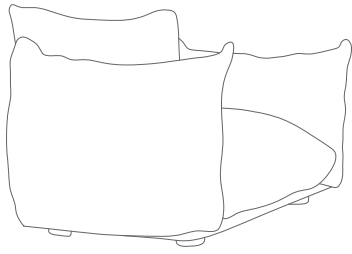

Catalog product-fabric

NB21-Linen



02

Alternative fabric
Boucle,Linen and Linen teddy

Catalog product-Legs

Black painted metal leg



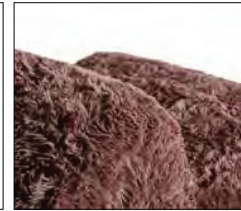

RIO ARMCHAIR

TECHNICAL SPECIFICATIONS

INTERIOR STRUCTURE SOLID WOOD AND ZIGZAG BOW

SEAT CUSHION GOOSE DOWN & FIBER

BACK GOOSE DOWN & FIBER

UPHOLSTERY LOOSE

MAINTENANCE We recommend shaking and fluffing-up the cushions regularly to maintain the shape. This should be done after removing the cushions from the structure for improved air circulation. For maintenance of fabric and leather, please contact your retailer.



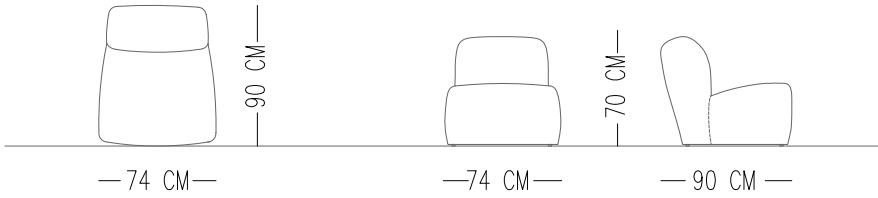
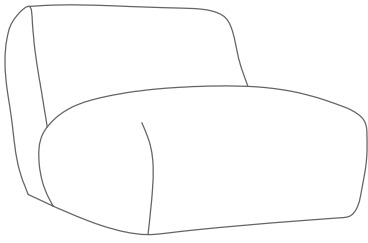

Catalog product-fabric

N-A25/Linen teddy



08

Alternative fabric
Boucle, Linen and Linen teddy

Catalog product-Legs

Hidden Leg





BEAR ARMCHAIR

TECHNICAL SPECIFICATIONS

INTERIOR STRUCTURE SOLID WOOD, STEEL AND ELASTIC COLUMN

SEAT CUSHION GOOSE DOWN AND FIBER MIX

BACK BACK CUSHION 100% DOWN/FEATHERS

UPHOLSTERY TIGHT



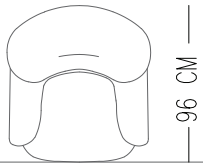
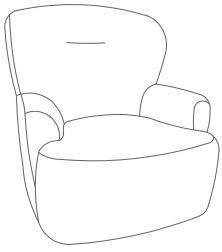

— 88 CM —

— 96 CM —

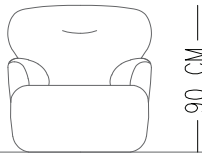

— 88 CM —

— 90 CM —



— 96 CM —

Catalog product-fabric

N-A16/Linen teddy



44423

Alternative fabric
Boucle,Linen and Linen teddy

Catalog product-Legs

Hidden leg



MARSEL ARMCHAIR

TECHNICAL SPECIFICATIONS

INTERIOR STRUCTURE SOLID WOOD & PAPEL AND ELASTIC COLUMN

SEAT CUSHION HIGH RESILIENT FOAM

BACK GOOSE DOWN & FIBER

UPHOLSTERY TIGHT

MAINTENANCE ALL DECORATIVE CUSHIONS ARE %100 GOOSE DOWN, QUANTITY AND DIMENSIONS ARE AS PER TECHNICAL DRAWING

We recommend shaking and fluffing-up the cushions regularly to maintain the shape.
This should be done after removing the cushions from the structure for improved air circulation.
For maintenance of fabric and leather, please contact your retailer



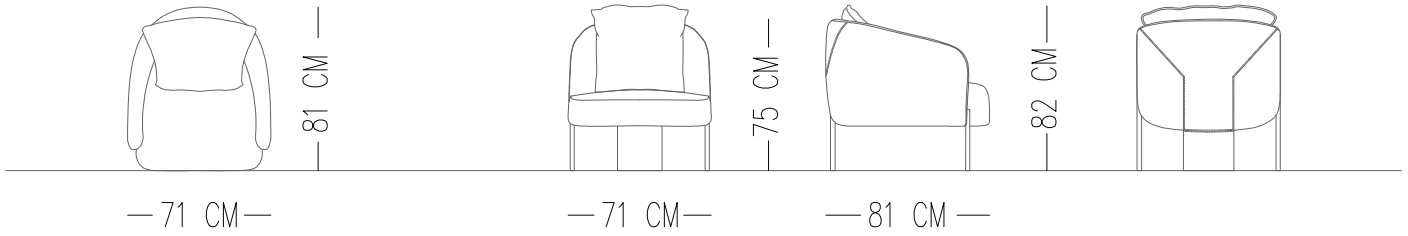
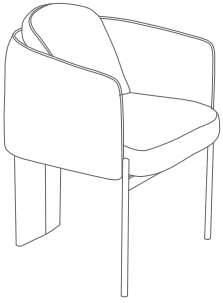

Alternative fabric

N-B21/Linen



02

Linen&Faux leather,Linen& Leather
Boucle&Faux leather,Boucle & Leather
Linen teddy&Faux leather, Linen teddy & Leather
Linen,Faux leather;Boucle,Linen teddy and Leather

Catalog product-Legs

Black painted metal leg





BULUT ARMCHAIR

TECHNICAL SPECIFICATIONS

INTERIOR STRUCTURE	SOLID WOOD, STEEL AND MDF WITH ZIGZAG BOW
SEAT CUSHION	HIGH RESILIENT FOAM & DOWNTOP
BACK	BACK CUSHION 100% DOWN/FEATHERS
UPHOLSTERY	TIGHT

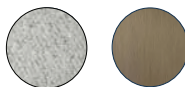

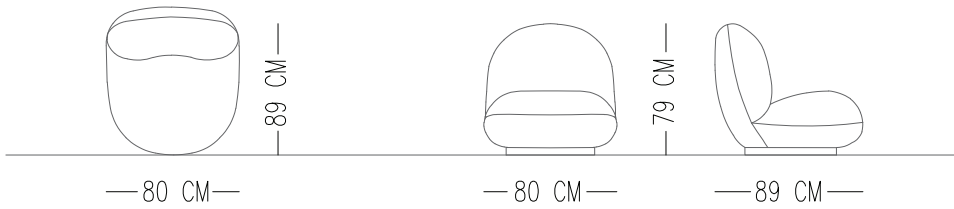
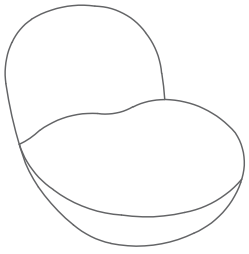

Catalog product-fabric

N-A16/Linen teddy



46860

Alternative fabric
Boucle,Linen and Linen teddy

Catalog product-Legs

Wooden base brass polish





CHERRY ARMCHAIR

TECHNICAL SPECIFICATIONS

INTERIOR STRUCTURE SOLID WOOD, STEEL AND MDF WITH ZIGZAG BOW

SEAT CUSHION HIGH RESILIENT FOAM & DOWNTOP

BACK BACK CUSHION 100% DOWN/FEATHERS

UPHOLSTERY TIGHT



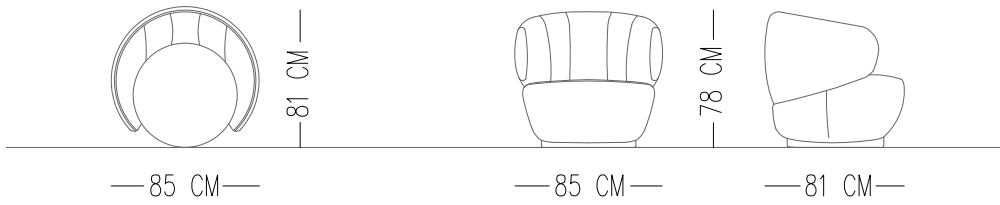
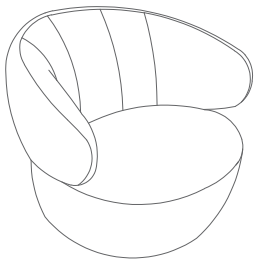

Catalog product-fabric

N-A20/Boucle



DLY 01

Alternative fabric
Boucle, Linen and Linen teddy

Catalog product-Legs

Swivel Mechanism



EVA ARMCHAIR

TECHNICAL SPECIFICATIONS

INTERIOR STRUCTURE FRAME BEECH CONTRA, STEEL AND ELASTIC COLUMN

BACK BACK CUSHION 100% DOWN/FEATHERS

UPHOLSTERY LOOSE



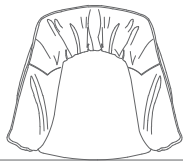
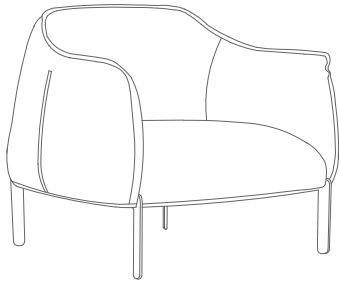

— 85 CM —

— 75 CM —

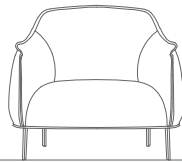

— 85 CM —

— 75 CM —

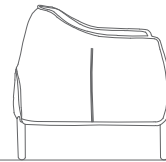

— 75 CM —

Catalog product-fabric

N-C13/Faux leather



339

Alternative fabric
Linen, Nubuck, Leather, Faux leather and Suede

Catalog product-Legs

Black painted metal leg





NASCAR ARMCHAIR

TECHNICAL SPECIFICATIONS

INTERIOR STRUCTURE SOLID WOOD, STEEL AND ELASTIC COLUMN

SEAT CUSHION BACK CUSHION 100% DOWN/FEATHERS

BACK TIGHT



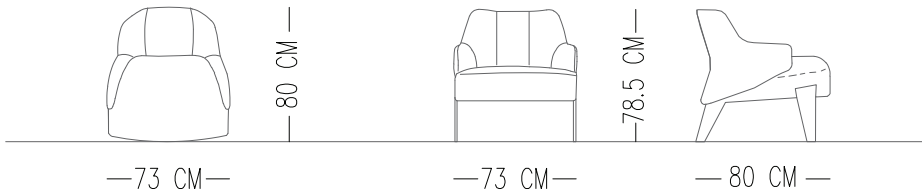
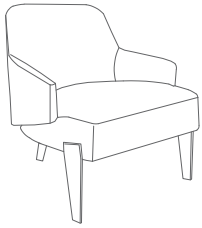

Catalog product-fabric

N-D10/Faux leather



23512

Alternative fabric
Linen, Nubuck, Chenille, Faux leather and
Leather

Catalog product-Legs

Aged brass metal





NORA ARMCHAIR

TECHNICAL SPECIFICATIONS

INTERIOR STRUCTURE SOLID WOOD, STEEL AND ELASTIC COLUMN

SEAT CUSHION HIGH RESILIENT FOAM & DOWNTOP

BACK BACK CUSHION 100% DOWN/FEATHERS

UPHOLSTERY TIGHT



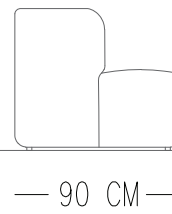
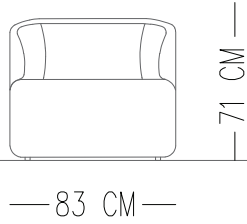
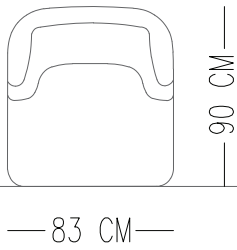
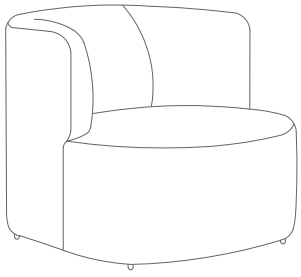

Catalog product-fabric

N-B13/Linen



Krem 86-15

Alternative fabric
Linen, Nubuck, Faux leather and Suede

Catalog product-Legs

Hidden Leg



NORDEN ARMCHAIR

TECHNICAL SPECIFICATIONS

INTERIOR STRUCTURE SOLID WOOD, STEEL AND MDF WITH ZIGZAG BOW

SEAT CUSHION HIGH RESILIENT FOAM & DOWNTOP

BACK BACK CUSHION 100% DOWN/FEATHERS

UPHOLSTERY TIGHT

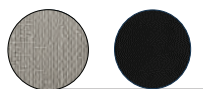

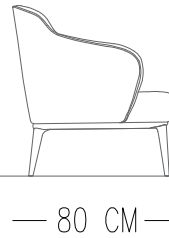
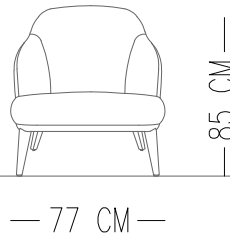
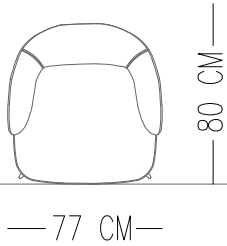
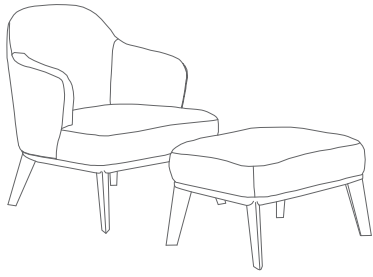

Catalog product-fabric

N-D13/Linen



1002

Alternative fabric
Linen&Faux leather,Linen&Leather
Boucle&Faux leather,Boucle &Leather
Linen teddy&Faux leather,Linen teddy&Leather
Linen,Faux leather,Boucle, Linen teddy and Leather

Catalog product-Legs

Black Wood





ZETA ARMCHAIR

TECHNICAL SPECIFICATIONS

STRUCTURE INTERIOR	SOLID WOOD, STEEL AND ELASTIC COLUMN
STRUCTURE PADDING	35 DNS SOFT FOAM ON PAD GOOSE DOWN
SEAT CUSHION	HIGH RESILIENT FOAM & DOWNTOP
BACK	BACK CUSHION 100% DOWN/FEATHERS
UPHOLSTERY	LOOSE
MAINTENANCE	ALL DECORATIVE CUSHIONS ARE %100 GOOSE DOWN, QUANTITY AND DIMENSIONS ARE AS PER TECHNICAL DRAWING We recommend shaking and fluffing-up the cushions regularly to maintain the shape. This should be done after removing the cushions from the structure for improved air circulation. For maintenance of fabric and leather, please contact your retailer.



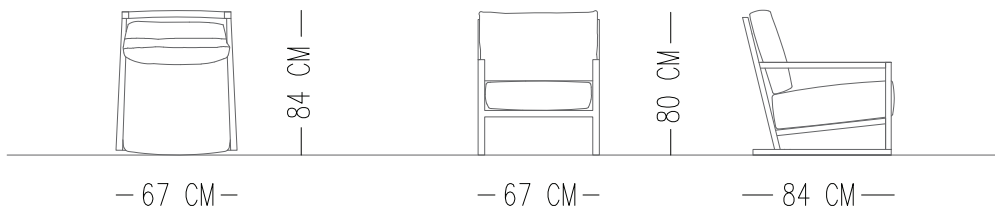
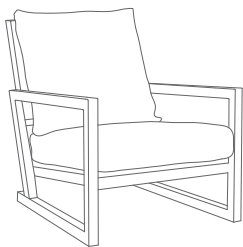

Catalog product-fabric

N-B29/Linen



08

Alternative fabric
Linen,Linen teddy,Boucle,Nubuck,Velvet,
Faux leather,Leather and Suede

Catalog product-Legs

Wood black oak





DARI ARMCHAIR

TECHNICAL SPECIFICATIONS

INTERIOR STRUCTURE	IROKO WOOD AND OAK WOOD
LEGS	IROKO WOOD AND OAK WOOD



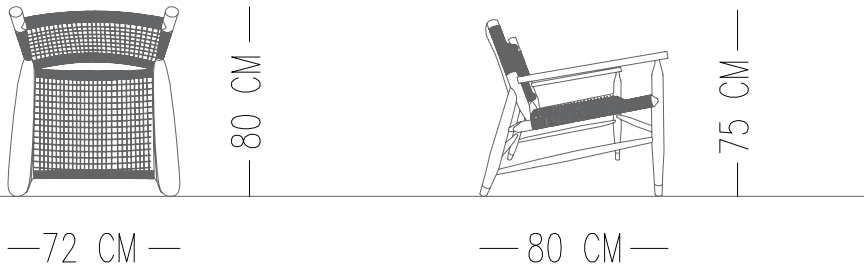
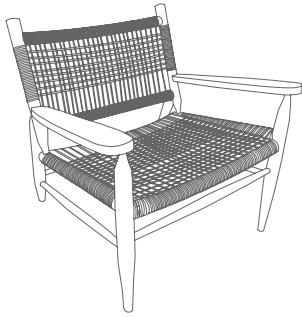

Catalog product-fabric

N-A14/Cotton rope



Brown Rope

Alternative fabric
Only N-A14 are available for this model

Catalog product-Legs

Ireko wood



Alternative leg
Oak wood



DROP ARMCHAIR

TECHNICAL SPECIFICATIONS

INTERIOR STRUCTURE	IROKO WOOD & 35 DNS FOAM WITH ZIGZAG BOW MATERIAL VARIATION : WOODEN STRUCTURE IS AVAIBALE IN OAK WOOD OR WALNUT WITH NATURAL POLISH
SEAT CUSHION	35 DNS FOAM
BACK	FIBER
UPHOLSTERY	TIGHT
MAINTENANCE	ALL DECORATIVE CUSHIONS ARE %100 GOOSE DOWN, QUANTITY AND DIMENSIONS ARE AS PER TECHNICAL DRAWING We recommend shaking and fluffing-up the cushions regularly to maintain the shape. This should be done after removing the cushions from the structure for improved air circulation. For maintenance of fabric and leather, please contact your retailer.



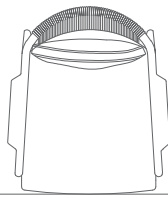
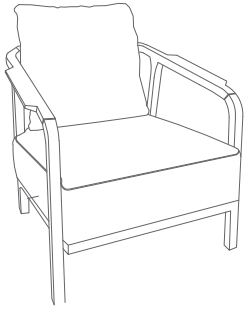

— 70 CM —

— 81 CM —

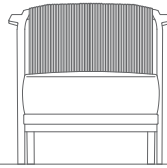

— 70 CM —

— 69.5 CM —

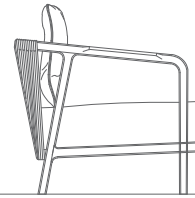

— 81 CM —

— 82 CM —

Catalog product-fabric

N-B40 Linen



Laci-01

Alternative fabric
Linen, Linen teddy, Boucle, Nubuck, Velvet, Faux leather,
Leather and Suede

Catalog product-Legs

Iroko Hardwood With Natural Polish





EXPERIENCE AN EMBRACE OF HOME WITH OUR
ENVELOPING SHAPES AND SHADES, CREATING A
WARM AND INVITING ATMOSPHERE.



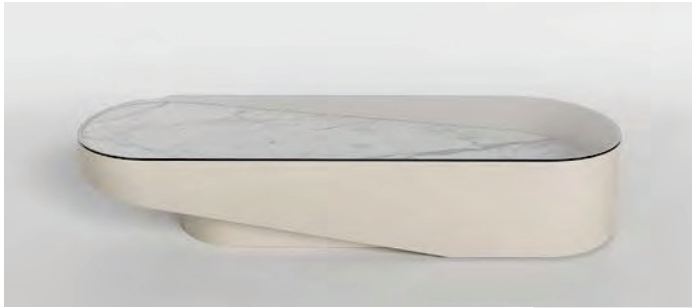

YUI COFFEE TABLE

TECHNICAL SPECIFICATIONS

- 1 LAQUER PAINTED SILK MAT COLOR ON WOOD
- 2 GLASS 8 MM
- 3 PORCELAIN CERAMIC-5MM-INCLINED



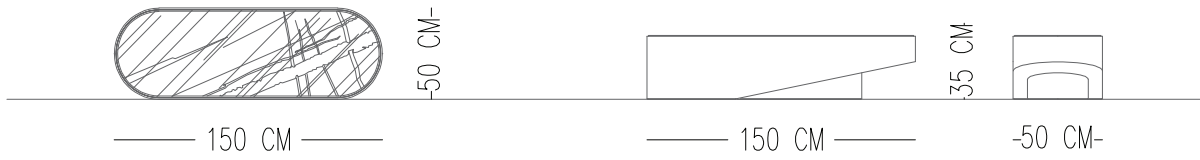

Catalog product

Lacquer Paint



Soft Touch

Clear glass



Calacatta Michelangelo
Polish



Alternative material

Alternative material/All Laquer paint ,all glass and all porcelain ceramic

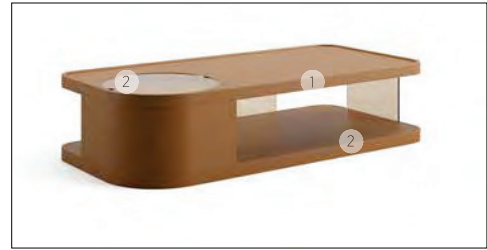

YUI COFFEE TABLE - 2

TECHNICAL SPECIFICATIONS

- 1 LAQUER PAINTED WOOD- SILK MAT-COLOR
- 2 8 MM BRONZE GLASS



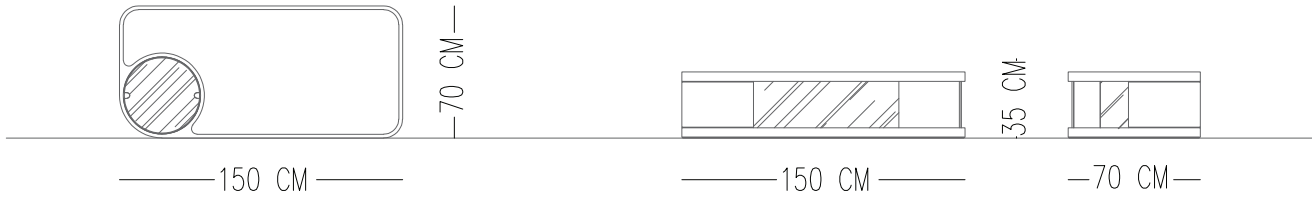

Catalog product

Lacquer Painted
On wood



Cinnamon-matt

Glass



Bronze

Alternative material
All Lacquer Paint and all glass



LOTUS COFFEE TABLE

TECHNICAL SPECIFICATIONS

STRUCTURE TOP: TEXTURED CAST BRONZE GLASS AND BRONZE METAL FITTINGS
LEGS: LAQUER PAINT NUDE MATT



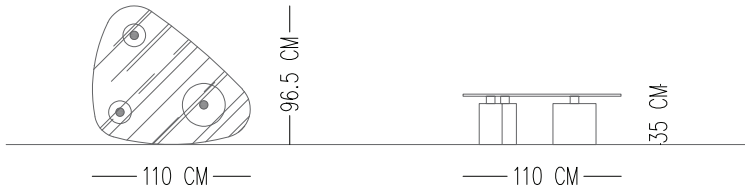

Catalog product-Top

Glass



Bronze texture
glass

Laquer painted
on wood



Nude-matt

Alternative material
All Lacquer Paint and all glass



VOGUE COFFEE TABLE

TECHNICAL SPECIFICATIONS

STRUCTURE PINK TRAVERTINE AND CALACATTA MICHELANGELO PORCELAIN CERAMIC
LAQUERED PAINTED WOOD-POLISH



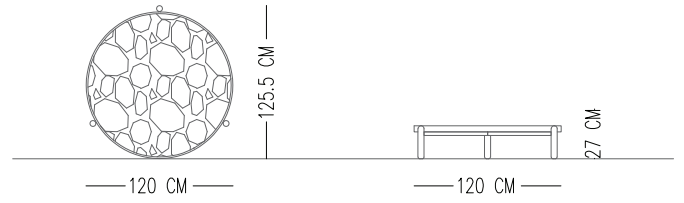
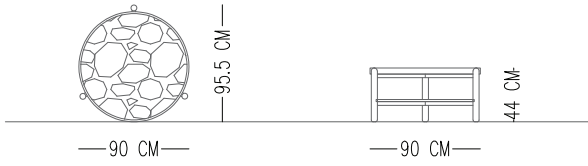

Catalog product

Travertine



Pink

Lacquer Painted on
Wood



Ruby

Porcelain Ceramic



Calacatta

Alternative material

All marble, porcelain ceramic and lacquer paint in

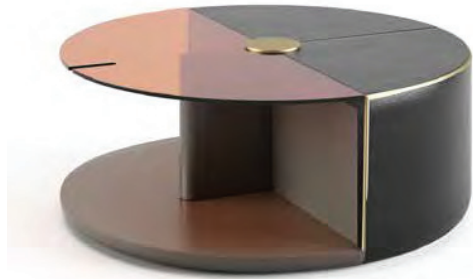

ORBIT COFFEE TABLE

TECHNICAL SPECIFICATIONS

STRUCTURE TOP: 8 MM TEMPERED BRONZE GLASS AND LEATHER
 SIDE: LEATHER COVERED WOOD AND METAL
 BOTTOM: LAQUERED PAINTED ON WOOD



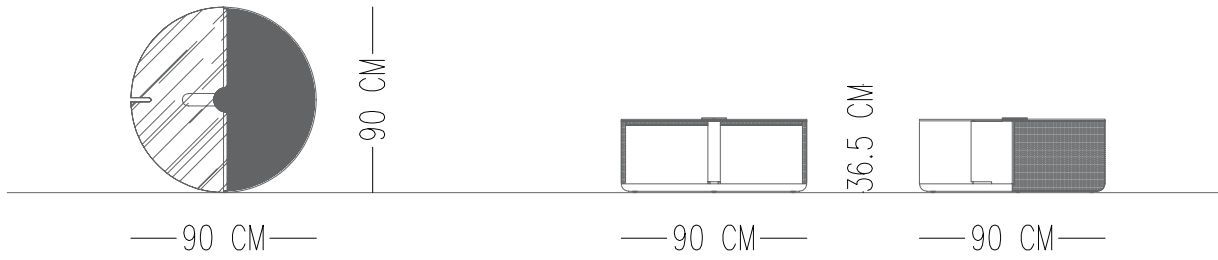

Catalog product

Glass



Bronze

Leather



Riva 339

Laquer painted on
wood cinnamon



Metal



01

Alternative material
All glass,leather,metal and laquer paint



LILY COFFEE TABLE

TECHNICAL SPECIFICATIONS

STRUCTURE

SANDBLASTED OAK WOOD VENEERING BLACK SMOKED TRANSPARENT MAT

CIRCLE TABLE: LAQUER PAINTED ON WOOD RUBY





Catalog product

Sandblasted
Oak wood veneering



Black smoked Matt
transparent varnish

Lacquer Painted on
Wood



Ruby

Alternative material
All Wood Veneering and Laquer pain



CIRCLE COFFEE TABLE

TECHNICAL SPECIFICATIONS

STRUCTURE

SANDBLASTED OAK WOOD VENEERING BLACK SMOKED TRANSPARENT MAT

WOOD TRAY IN THE MIDDLE

PORCELAIN CERAMIC/CARRARA SMALL ROUND TABLE

SILVER METAL LEG



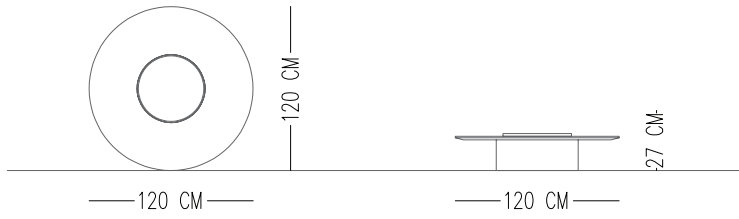

Catalog product

Wood veneering



Sandblasted Oak veneering with
black Matt transparent varnish

Metal Finish



Painted Dark Silver

Porcelain Ceramic



Calacatta

Alternative material
All Wood Veneering and Laquer paint



ASTRA COFFEE TABLE

TECHNICAL SPECIFICATIONS

STRUCTURE

TOP: NATURAL STONE

BASE: NATURAL WOOD



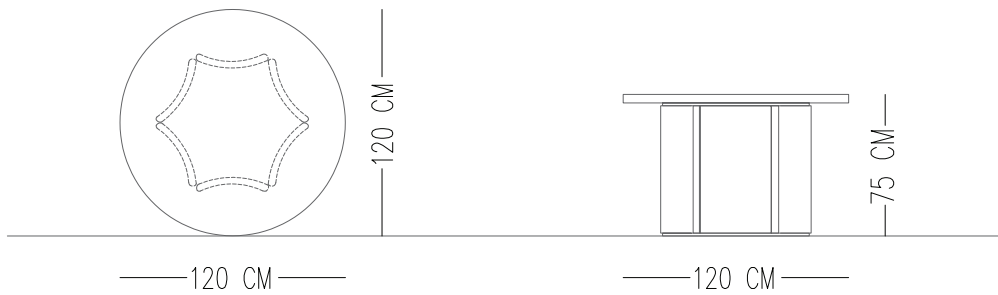

Catalog product

Top
Natural stone



Catalog product

Legs
Natural wood



Alternative material
Legs are natural wood painted black



OTTOMAN COFFEE TABLE

TECHNICAL SPECIFICATIONS

STRUCTURE

WOOD BLACK COLOR

ALTERNATIVE: WHITE WASH FINISHING



Catalog product



Wood Black Color

Alternative material: Teak wood black finishes,
White patinated teak wood



AUDREY COFFEE TABLE

TECHNICAL SPECIFICATIONS

TABLE TOP / BASE

LAQUER PAINTED ON WOOD (MATT)

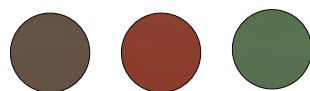

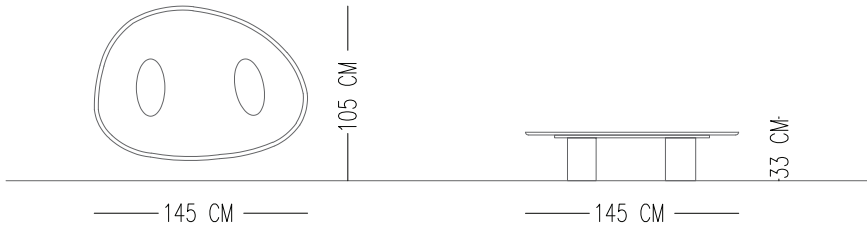
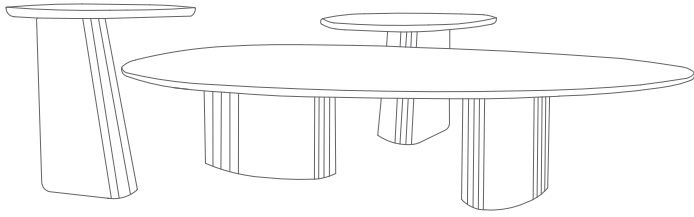

Catalog product

Table Top/Base
Lacquer Painted on wood
(matt)



Lacquer Painted on wood
(matt)



Lacquer Painted on wood
(matt)



Alternative material
All Wood Laquer Paint in Norde Material Catalog
All marble and Porcelain ceramic

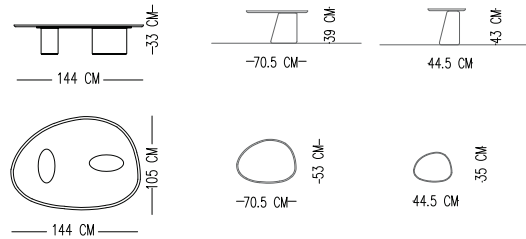



KIENA COFFEE TABLE

TECHNICAL SPECIFICATIONS

STRUCTURE

TOP: SANDBLASTED OAK WOOD VENEERING WITH BLACK VARNISH



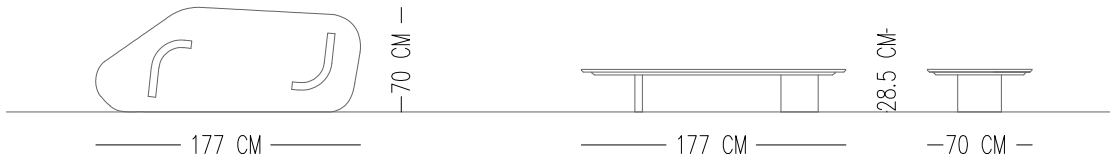
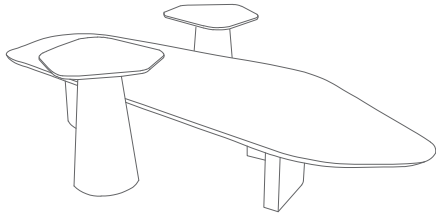

Catalog product

Top
Sandblasted Oak wood Veneering
with black Varnish



Leg
Sandblasted Oak wood Veneering
with black Varnish



Alternative material
All Wood Laquer Paint



MARLON COFFEE TABLE

TECHNICAL SPECIFICATIONS

STRUCTURE

OAK VENEERING ON MDF WITH SANDBLASTED BLACK PAINT



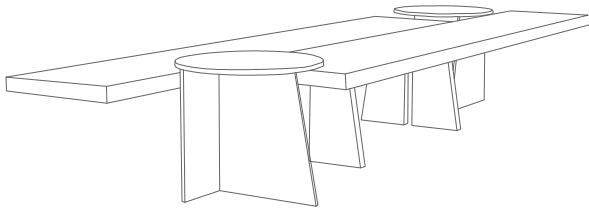

Catalog product

Top
Sandblasted Oak wood Veneering
with black Varnish



Leg
Sandblasted Oak wood Veneering
with black Varnish



Marlon Side table
Smoked glass



Alternative material
Top-Legs /All Wood Veneering in Norde Material Catalog
Side Table/All glass and painted glass



OLIVER COFFEE TABLE

TECHNICAL SPECIFICATIONS

TOP MARQUETERIE VENEERING & CERAMIC & PAINTED GLASS

STRUCTURE SANDBLASTED OAK WOOD VENEERING WITH NATURAL VARNISH



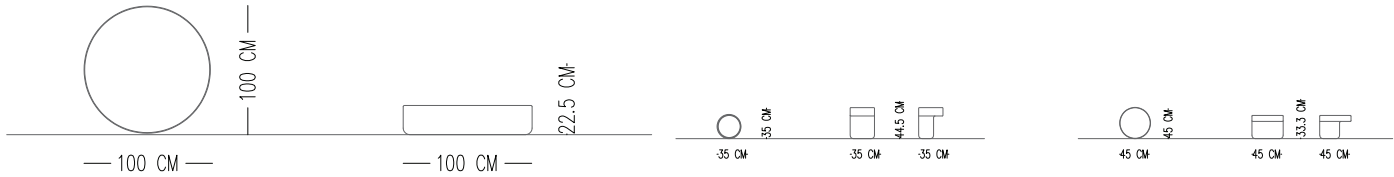
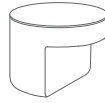
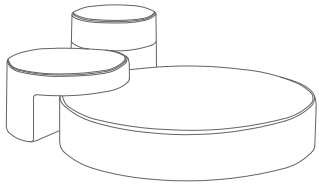

Catalog product

Structure&top
Oak wood Veneering
with natural Varnish



Structure&top
Oak wood Veneering
with painted glass-cappuccino



Structure&top
Oak wood Veneering
with porcelain ceramic calacatta



Alternative material
Structure/Top/All Wood Veneering
Top/All glass and painted glass
Top/All porcelain ceramic



TRIO COFFEE TABLE

TECHNICAL SPECIFICATIONS

STRUCTURE TOP: BRONZE GLASS
LEGS: METAL LEG - CAPPUCCINO

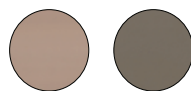

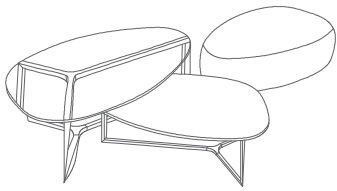

Catalog product

Top



Bronze Glass

Leg



Cappuccino painted
metal leg

Alternative material
All glass and metal finishes

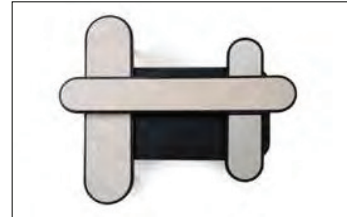

DOMINO COFFEE TABLE

TECHNICAL SPECIFICATIONS

STRUCTURE

TOP: SANDBLASTED OAK WOOD VENEERING WITH BLACK VARNISH

TOP: ELEGANT BEIGE MARBLE

TOP: SMOKED MIRROR

LEGS :BLACK PAINTED METAL



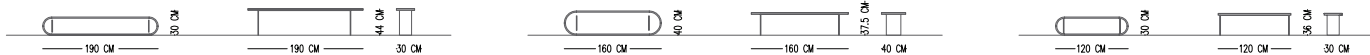
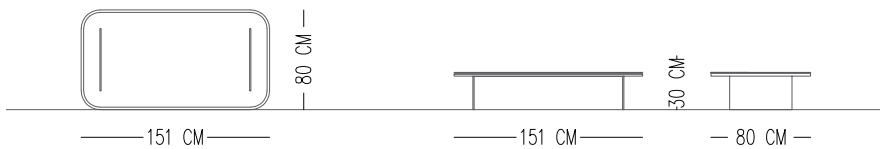
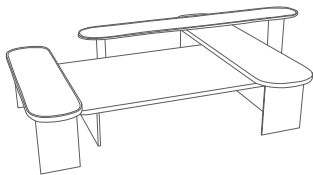

Catalog product

Top
Elegant beige
Honed marble



Legs
Painted metal
black



Top/Legs
Oak wood veneering with
black varnish



Top
Elegant beige
Honed marble



Legs
Painted metal
black



Top
Smoked mirror



Legs
Painted metal
black



Alternative material
Top/All Wood Veneering
Top/All Mirror
Top/All marble& porcelain ceramic
All Lacquer painted on wood

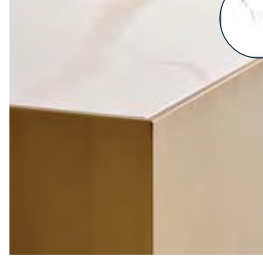
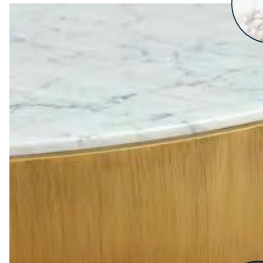

DRANK COFFEE TABLE

TECHNICAL SPECIFICATIONS

STRUCTURE

FRAME: AGED BRASS PAINT FINISH ON PLYWOOD
TOP: CALACATA MARBLE (CIRCLE) AND CALACATA CERAMIC(SQUARE)



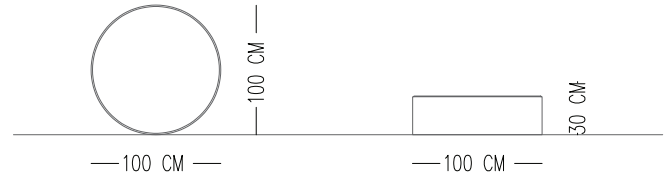
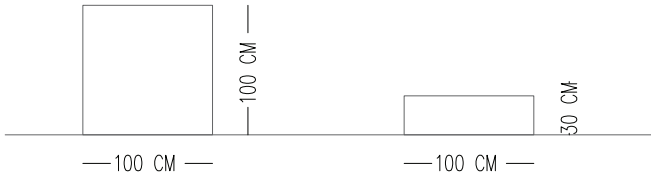
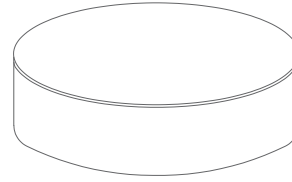
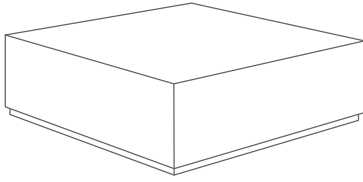

Catalog product

Structure
Painted metal 05
Aged brass metal finish on wood



Top/Porcelain
Calacatta marble



Structure
Painted metal 05
Aged brass metal finish on wood



Top
Porcelain ceramic calacatta



Alternative material
Structure/All painted metal color on wood
All laquer painted on wall
Top//All marble& porcelain ceramic
Top/All glass



OSLO COFFEE TABLE

TECHNICAL SPECIFICATIONS

STRUCTURE

SMOKED OAK VENEERING ON WOOD WITH NATURAL VARNISH WITH AGED BRASS BASE & DETAILS



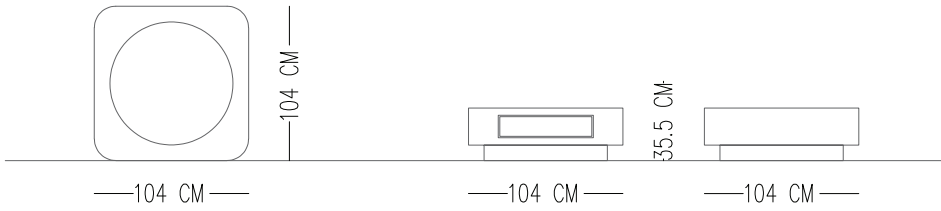
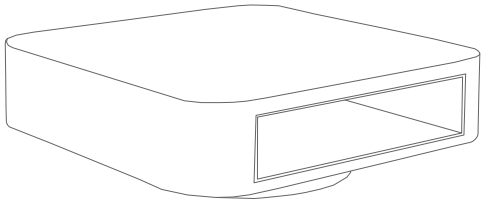

Catalog product

Base
Smoked oak veneering with
Natural varnish with aged brass base & details



Legs
Painted metal O5
Aged brass metal finish



Alternative material
All Oak wood veneering
finishes

Alternative material
All RAL and Metal color
finishes



YUI SIDE TABLE-1

TECHNICAL SPECIFICATIONS

- 1 LAQUER PAINTED SILK MAT COLOR ON WOOD
- 2 GLASS 8 MM
- 3 PORCELAIN CERAMIC-5MM-INCLINED
- 4 METAL LEG



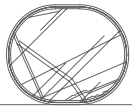

45 CM-

-55 CM-

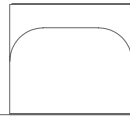

50 CM-

-55 CM-



45 CM-

Catalog product

Structure



Lacquer Painted on
Wood Soft touch



Bronze Glass



Calacatta
Michelangelo Polish



Painted Metal

Alternative material

All Laquer paint and porcelain ceramic



YUI SIDE TABLE-2

TECHNICAL SPECIFICATIONS

- 1 LEATHER COVERED WOOD
- 2 FABRIC COVERED WOOD
- 3 LEG/ GLASS 12 MM



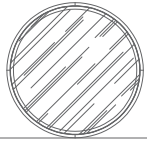

-50 CM-

-50 CM-

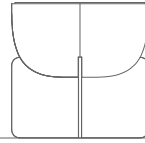

-50 CM-

-50 CM-

Catalog product

Structure
Nb45-Nubuck



501

Structure
ND-11



60444

Leg



Bronze Glass

Alternative material
All leather/laquer paint and glass



YUI SIDE TABLE-3

TECHNICAL SPECIFICATIONS

- 1 FABRIC COVERED WOOD
- 2 PORCELAIN CERAMIC TOP OF TABLE
- 3 LEG/ METAL





Catalog product

Structure
Nb45-Nubuck



501

Top coffee table



Calacatta Michelangelo
Polish

Leg



Cinnamon
Metal

Alternative material
All leather and metal



YUI SIDE TABLE-4

TECHNICAL SPECIFICATIONS

- 1 LAQUER PAINTED WOOD-SILK MAT-COLOR1
- 2 LAQUER PAINTED WOOD-SILK MAT-COLOR2
- 3 PORCELAIN CERAMIC TOP OF TABLE

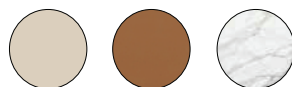

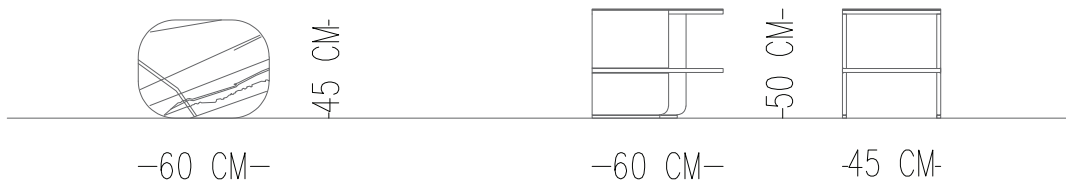

Catalog product

Structure



Lacquer Painted On
Wood Soft touch

Structure



Lacquer Painted On
Wood Silk Mat

Top coffee table



Calacatta
Michelangelo Polish

Alternative material

All Laquer paint and porcelain ceramic



YUI SIDE TABLE-5

TECHNICAL SPECIFICATIONS

- 1 LAQUER PAINTED WOOD- SILK MAT-COLOR TABLE AND INSIDE PORCELAIN CERAMIC-5 MM
- 2 8 MM BRONZE GLASS
- 3 METAL LEG





Catalog product

Structure



Lacquer Painted on
Wood Soft touch



Bronze Glass



Calacatta
Michelangelo Polish



Painted Metal

Alternative material

All Laquer paint and porcelain ceramic



AUDREY C SIDE TABLE

TECHNICAL SPECIFICATIONS

STRUCTURE

TOP:LAQUER PAINT ON WOOD-CAPPUCINO

LEG AND BOTTOM TRAY:CHROME





Catalog product

Top



Lacquer Painted
On Wood Cappuccino

Legs



Chrome

Alternative material
All Wood Laquer paint and metal



BELLA C SIDE TABLE

TECHNICAL SPECIFICATIONS

STRUCTURE

TOP: OAK VEENEERING WITH BLACK VARNISH

LEG: BLACK METAL





Catalog product

Top
Oak Veneering



Black mat varnish

Legs
Metal



Black

Alternative material
All Wood Veneering and metal



QUATTRO SIDE TABLE

TECHNICAL SPECIFICATIONS

STRUCTURE TOP AND LEGS/OAK WOOD VENEERING WITH
NATURAL SANDBLASTED VARNISH



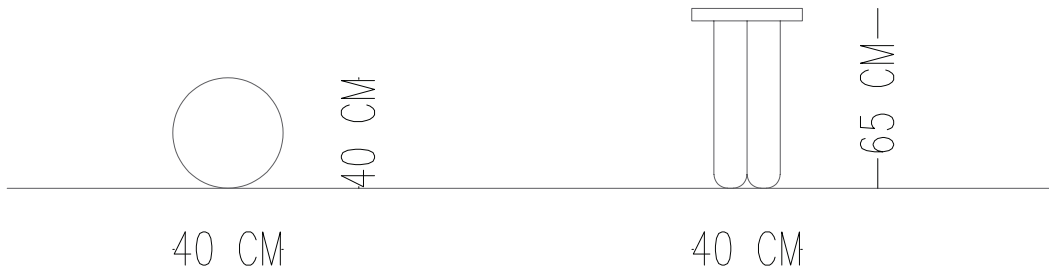

Catalog product

Top
Oak wood veneering natural
varnish & sandblasted finish



Alternative material
All oak wood veneering and all Laquer paint



SHERLOCK SIDE TABLE

TECHNICAL SPECIFICATIONS

STRUCTURE

TOP: TEXTURED GLASS

BRASS METAL PIECE IN THE MIDDLE OF THE TOP TABLE

MID FOOT: SMOKED TRANSPARENT MAT BLACK VARNISH

LEG: BRASS METAL DETAIL



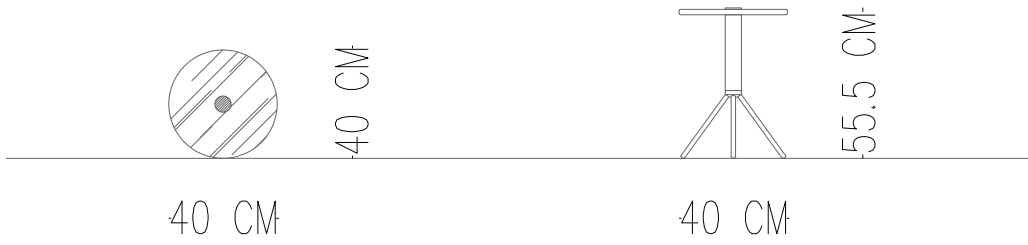

Catalog product

Top
Smoked Transparent
Mat black varnish



Glass
Textured glass



Metal
Brass



Alternative material
All oak wood veneering and all Laquer paint



WALKER SIDE TABLE

TECHNICAL SPECIFICATIONS

STRUCTURE

SANDBLASTED OAKWOOD VENEERING WITH
BLACK POLISH VARNISH
OPENED DRAWER AND CABINET DOOR



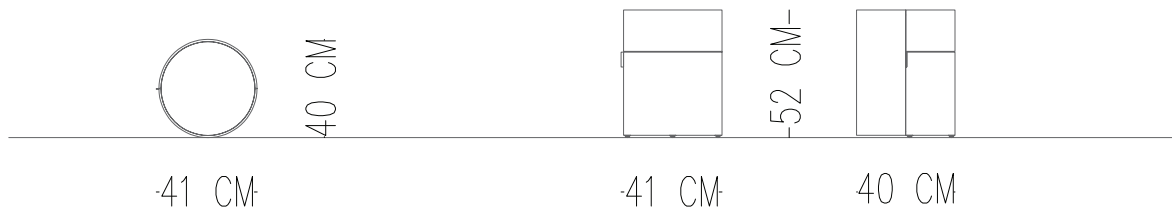

Catalog product

Sandblasted Oakwood
Veneering



Black Polish Varnish

Alternative material
All oak wood veneering and all Laquer paint



MERGE SIDE TABLE

TECHNICAL SPECIFICATIONS

STRUCTURE

BASE: RIFT CUT OAK WOOD VENEERING WITH BLACK VARNISH
TOP: PORCELAIN CERAMIC CALACATA
AGED BRAS DETAIL



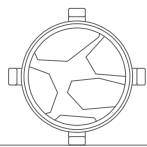

-49 CM-

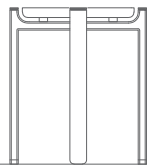

-56 CM-

-49 CM-

-49 CM-

Catalog product

Sandblasted Oakwood
Veneering



Black Polish Varnish

Metal



Brass

Porcelain Ceramic



Calacatta

Alternative material

All Wood Veneering, marble and porcelain ceramic
Catalogue



AUDREY SIDE TABLE

TECHNICAL SPECIFICATIONS

TABLE TOP / BASE

LAQUER PAINTED ON WOOD (MATT)



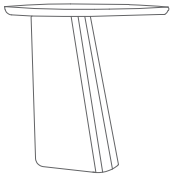

Catalog product

Lacquer Painted on
wood (matt) Terracota



Lacquer Painted on
wood (matt) Eucalyptus
Green



Alternative material
All Wood Laquer Paint
All marble and Porcelain ceramic



KIENA SIDE TABLE

TECHNICAL SPECIFICATIONS

STRUCTURE

LAQUER PAINTED ON WOOD (MATT)



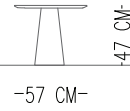
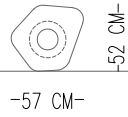
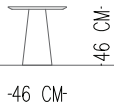
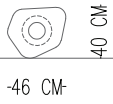

Catalog product

Lacquer Painted on wood
(matt) Terracota



Alternative material
All Wood Laquer Paint
All marble and Porcelain ceramic



BULUT SIDE TABLE

TECHNICAL SPECIFICATIONS

STRUCTURE

LARGER ONE: AGED BRASS METAL PAINT ON OAK VENEERING

SMALLER ONE: SANDBLASTED OAK WOOD VENEERING WITH WENGE VARNISH



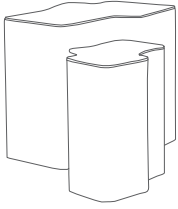

Catalog product

Structure
Sandblasted Oak Wood Veneering
Wenge Varnish



Top/Porcelain
ceramic-calacatta



Structure
Painted metal O4
Aged brass metal finish on oak veneering



Top
Smoked mirror



Alternative material
Structure/All Wood Veneering
Structure/All painted metal finish on oak veneering
Top/All marble& porcelain ceramic
Top/All mirror



DRANK SIDE TABLE

TECHNICAL SPECIFICATIONS

STRUCTURE

FRAME: AGED BRASS PAINT FINISH ON PLYWOOD
TOP: CALACATA MARBLE



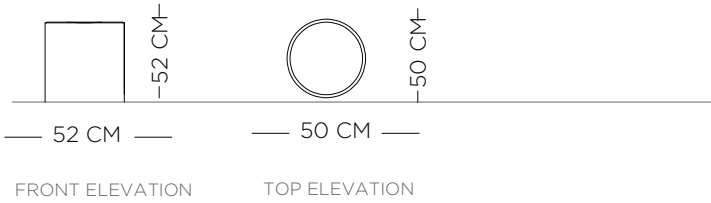
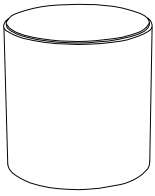

Catalog product

Structure
Painted metal 04
Aged brass metal finish on plywood



Top/Porcelain
Calacatta marble



Alternative material
Structure/All painted metal finish on plywood
Top//All marble& porcelain ceramic and glass, painted glass material
Top/All glass



FREE SIDE TABLE

TECHNICAL SPECIFICATIONS

STRUCTURE

TOP: CALACATTA MARBLE POLISHED
BASE: AGED BRASS METAL



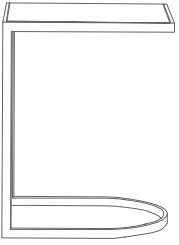

Catalog product

Base
Painted metal 04
Aged brass metal finish



Top/Porcelain
Calacatta marble polished



Alternative material
Base /All painted metal finish
Top//All marble& porcelain ceramic



MARLON SIDE TABLE

TECHNICAL SPECIFICATIONS

STRUCTURE

GLASS



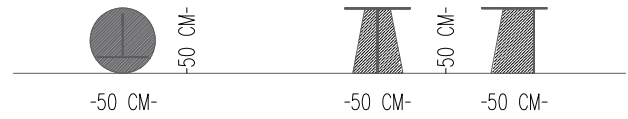
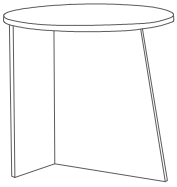

Catalog product

Smoked glass



Alternative material
Top//All glass finishes



SHOT SIDE TABLE

TECHNICAL SPECIFICATIONS

TOP	BLACK PAINTED METAL FINISH
BASE	CONCRETE FINISHED BOTTOM BASE





Catalog product

Top
Painted metal Black



Base
Concrete



Alternative material
All metal finishes



TOWER SIDE TABLE

TECHNICAL SPECIFICATIONS

STRUCTURE

AGED BRASS METAL FINISH



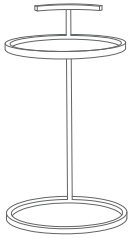

Catalog product

Structure
Painted metal O4
Aged brass metal finish



Alternative material
All metal finishes



ANATOLIA SIDE TABLE

TECHNICAL SPECIFICATIONS

STRUCTURE AGED BRASS METAL FINISH



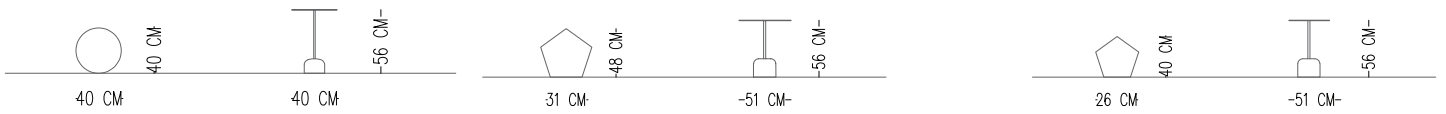
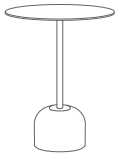

Catalog product

Structure
Painted metal O4
Aged brass metal finish



Leg
Painted metal Black



Alternative material
All metal finishes and ral color



TUNE SIDE TABLE

TECHNICAL SPECIFICATIONS

TOP	AGED BRASS METAL FINISH
BASE	AGED BRASS METAL
LEGS	ADJUSTABLE HEIGHT



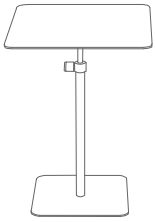

Catalog product

Top
Painted metal 04
Aged brass metal finish



Base
Painted metal 04
Aged brass metal finish



Alternative material
All metal finishes



ZED SIDE TABLE

TECHNICAL SPECIFICATIONS

STRUCTURE

MATERIAL-FIBER



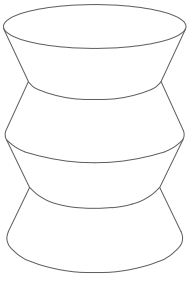

36 CM

36 CM

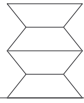

36 CM

45 CM

Catalog product

Fiber material



Soft touch



MUSHROOM STOOL

TECHNICAL SPECIFICATIONS

STRUCTURE TEAK WOOD NATURAL TEAK COLOR
ALTERNATIVE: TEAK WOOD BLACK



Catalog product



Teak color with natural teak color

Alternative material:Teak wood black finishes,
White patinated teak wood



FLAT STOOL

TECHNICAL SPECIFICATIONS

STRUCTURE

TTEAK WOOD LAMINATED NATURAL FINISHING



Catalog product



Teak color with natural teak color

Alternative material:Teak wood black finishes,
White patinated teak wood



UBE STOOL

TECHNICAL SPECIFICATIONS

STRUCTURE

TEAK WOOD LAMINATED BLACK FINISHING



Catalog product



Teak Wood Laminated Black
Finishing

Alternative material:Teak wood black finishes,
White patinated teak wood



SHERLOCK TROLLEY

TECHNICAL SPECIFICATIONS

STRUCTURE

BASE: FLAT CUT OAK WOOD VENEERING WITH
BLACK VARNISH - SANDBLASTED FINISH
AND SILVER METAL DETAIL

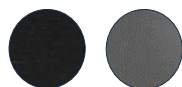



Catalog product

Sandblasted Oakwood
Veneering



Black Varnish

Metal



Dark Silver

Alternative material
All Wood Veneering and metal



VIBE SIDE TABLE

TECHNICAL SPECIFICATIONS

STRUCTURE SIDE EDGE/SANDBLASTED OAKWOOD VENEERING WITH BLACK VARNISH
TOP/PORCELAIN CERAMIC CALACATA



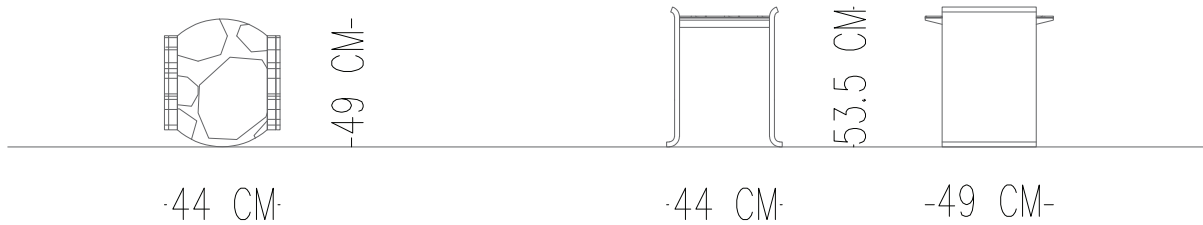

Catalog product

Oak Veneering



Sandblasted oak wood veneering

Porcelain Ceramic



Calacatta

Alternative material

All wood veneering and porcelain ceramic

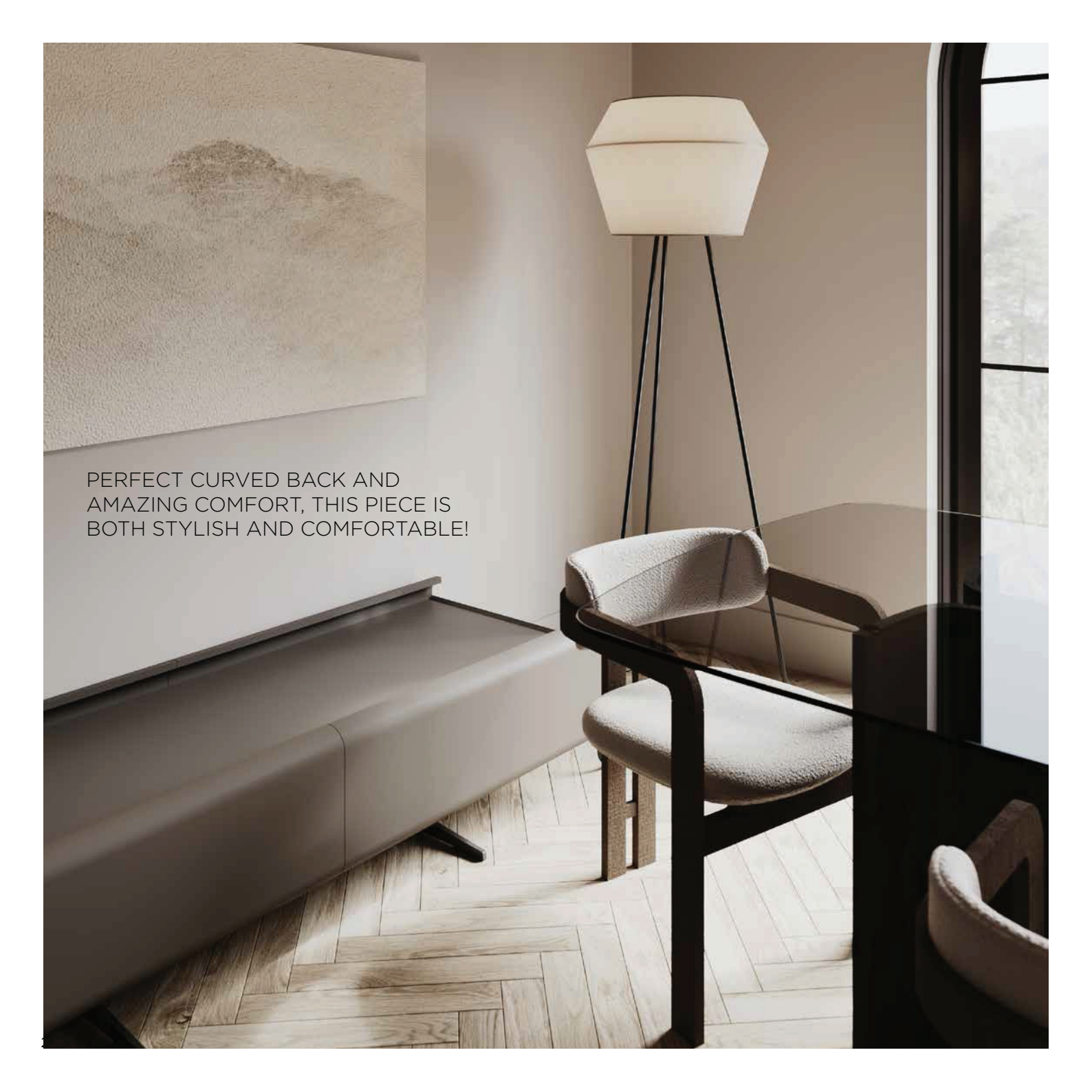
A modern interior scene featuring a curved armchair with a dark wood frame and light-colored upholstered seat and backrest. The chair is positioned next to a tall floor lamp with a white, hexagonal, segmented shade and a black tripod base. To the left, a long, low-profile sofa with a light-colored, textured surface is visible. The floor is made of light-colored wood planks in a herringbone pattern. A large window on the right side of the frame shows a view of trees outside. The overall aesthetic is minimalist and contemporary.

PERFECT CURVED BACK AND
AMAZING COMFORT, THIS PIECE IS
BOTH STYLISH AND COMFORTABLE!





ASTON CHAIR

TECHNICAL SPECIFICATIONS

INTERIOR STRUCTURE POLYURETHANE FOAM & STEEL STRUCTURE

PADDING 35 DNS SOFT FOAM

UPHOLSTERY TIGHT

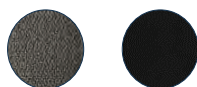

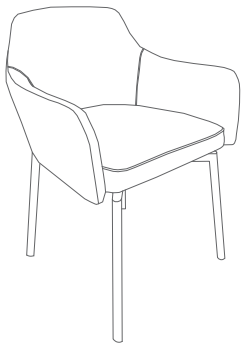

-62 CM-

-55 CM-

-62 CM-

-77.5 CM-

-55 CM-

Catalog product-fabric

N-C17/Linen



1-1015

Catalog product-Legs

Painted Metal Leg



Alternative fabric

Linen&Faux leather,Linen&Leather,Linen&Nubuck
Boucle&Faux leather,Boucle & Leather, Boucle&Nubuck
Linen teddy&Faux leather, Linen teddy&Leather, Linen teddy&Nubuck
Linen,Faux leather,Boucle,Linen teddy, Linen&Nubuck and Leather



CLEMENTINE CHAIR

TECHNICAL SPECIFICATIONS

INTERIOR STRUCTURE POLYURETHANE FOAM & SPECIAL PAINTED HARDWOOD STRUCTURE

PADDING 35 DNS SOFT FOAM

UPHOLSTERY TIGHT



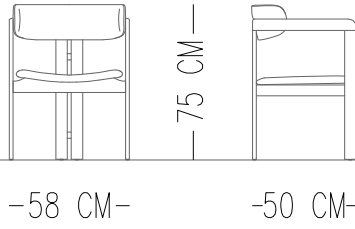
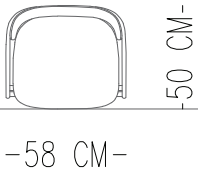
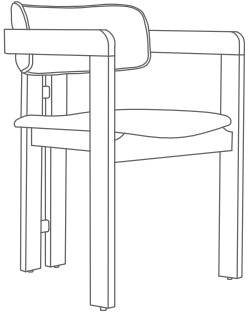

Catalog product-fabric

N-A11/Boucle



52664

Alternative fabric
Linen, Linen teddy, Boucle and Nubuck

Catalog product-Legs

Lacquer Painted on wood cappucino





MARLON CHAIR

TECHNICALS PECIFICATIONS

INTERIOR STRUCTURE PLYWOOD & FIBER

PADDING 35 DNS SOFT FOAM

UPHOLSTERY TIGHT



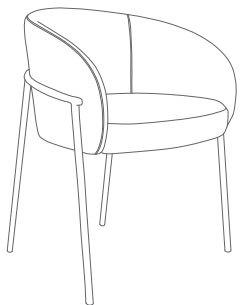

-64 CM-



-61 CM-



-64 CM-



-76 CM-



-61 CM-

Catalog product-fabric

N-B11/Linen



2120

Alternative fabric
Linen, Linen teddy, Boucle, Velvet, Suede
Faux leather, Leather and Nubuck

Catalog product-Legs

Painted Metal





AUDREY CHAIR

TECHNICAL SPECIFICATIONS

INTERIOR STRUCTURE PLYWOOD & FIBER

PADDING 35 DNS SOFT FOAM

UPHOLSTERY TIGHT



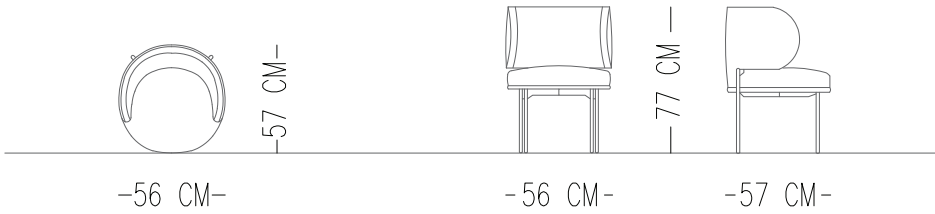
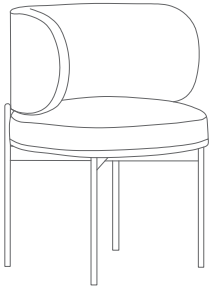

Catalog product-fabric

N-B31/Chenille



9904

Alternative fabric

Linen,Linen teddy,Boucle, Velvet,Suede and Nubuck

Catalog product-Legs

Painted Metal Leg





CORVUS CHAIR

TECHNICAL SPECIFICATIONS

INTERIOR STRUCTURE POLYURETHANE FOAM

PADDING 35 DNS SOFT FOAM

UPHOLSTERY TIGHT



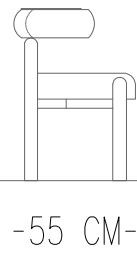
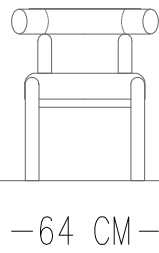
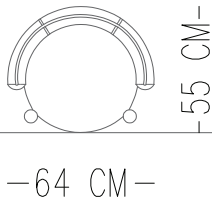
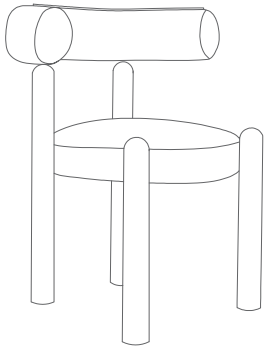

Catalog product-fabric

N-A20/Boucle



DLY 02

Alternative fabric
Linen, Linen teddy, Boucle and Suede

Catalog product-Legs

Painted metal





CECIL CHAIR

TECHNICAL SPECIFICATIONS

INTERIOR STRUCTURE	PLYWOOD & FIBER
PADDING	35 DNS SOFT FOAM
UPHOLSTERY	TIGHT

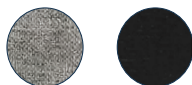

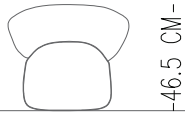

-53 CM-

-46.5 CM-



-53 CM-

-84.5 CM-

Catalog product-fabric

Linen



15

Alternative fabric
Linen,Boucle,Nubuck and Linen teddy

Catalog product-Legs

Painted Hardwood





MINNY CHAIR

TECHNICAL SPECIFICATIONS

INTERIOR STRUCTURE	PLYWOOD & FIBER
PADDING	35 DNS SOFT FOAM
UPHOLSTERY	TIGHT



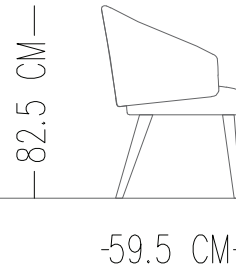
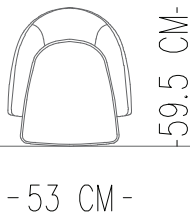
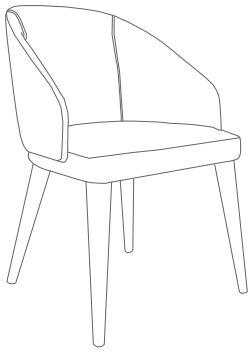

Catalog product-fabric

N-D13/Linen Leather



1002

Alternative fabric
Linen&Faux leather,Linen&Leather
Faux leather&Faux leather and Leather&Leather

Catalog product-Legs

Black Painted Hardwood





PARC CHAIR

TECHNICAL SPECIFICATIONS

INTERIOR STRUCTURE POLYURETHANE FOAM

PADDING 35 DNS SOFT FOAM

UPHOLSTERY TIGHT



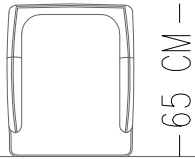
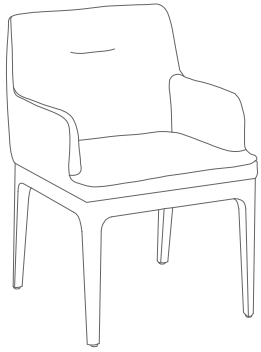

- 54 CM -

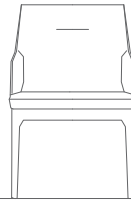

- 54 CM -

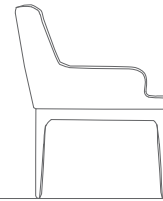
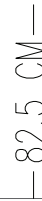

- 65 CM -

Catalog product-fabric

Linen



Krem/06

Alternative fabric

Linen, Nubuck, Velvet, Faux leather, Suede, and Leather

Catalog product-Legs

Black Painted Hardwood





PARTNER CHAIR

TECHNICAL SPECIFICATIONS

INTERIOR STRUCTURE	SOLID WOOD
PADDING	35 DNS SOFT FOAM
UPHOLSTERY	TIGHT



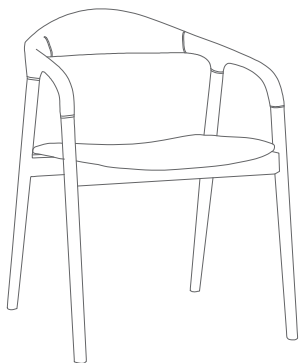

- 54 CM -

- 59 CM -

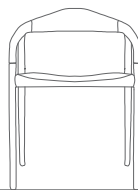

- 54 CM -

- 74.5 CM -



- 59 CM -

Catalog product-fabric

N-B15/Linen



AK 86-12

Alternative fabric

Linen, Nubuck, Velvet, Faux leather, Suede, and Leather

Catalog product-Legs

Solidwood





DAISY CHAIR

TECHNICALS PECIFICATIONS

INTERIOR STRUCTURE PLYWOOD & FIBER

PADDING 35 DNS SOFT FOAM

UPHOLSTERY TIGHT



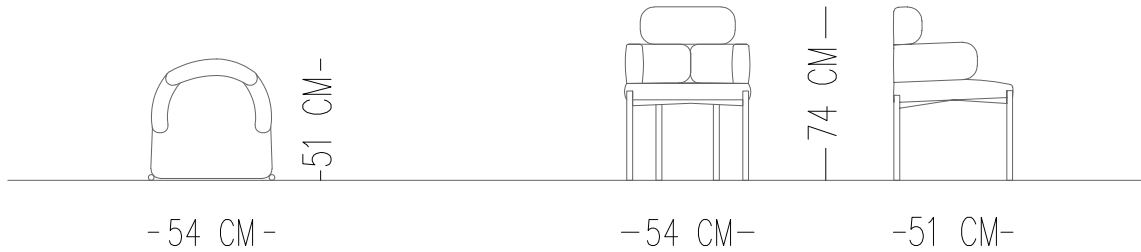
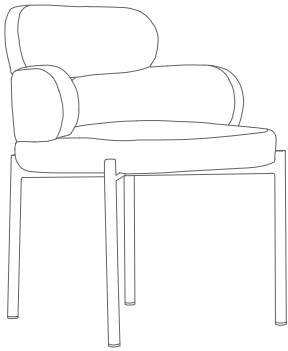

Catalog product-fabric

Linen teddy



Catalog product-Legs

Black painted metal leg



Alternative fabric

Linen, Nubuck, Velvet, Faux leather, Suede, and Leather



LOTUS CHAIR

TECHNICALS PECIFICATIONS

INTERIOR STRUCTURE PLYWOOD & FIBER

PADDING 35 DNS SOFT FOAM



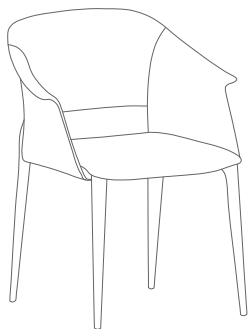

-59.5 CM-



-59.5 CM-

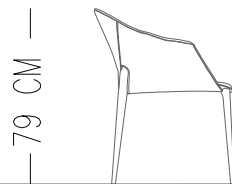

-63 CM-

Catalog product-fabric

Leather



Catalog product-Legs

Leather





MONA CHAIR

TECHNICALS PECIFICATIONS

INTERIOR STRUCTURE PLYWOOD & FIBER

PADDING 35 DNS SOFT FOAM

UPHOLSTERY TIGHT



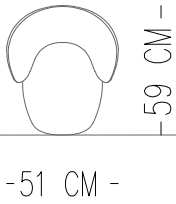

Catalog product-fabric

Leather



Catalog product-Legs

Painted metal leg





CORVUS BAR CHAIR

TECHNICALS PECIFICATIONS

INTERIOR STRUCTURE POLYURETHANE FOAM

PADDING 35 DNS SOFT FOAM

UPHOLSTERY TIGHT



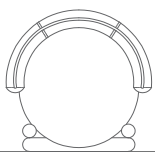
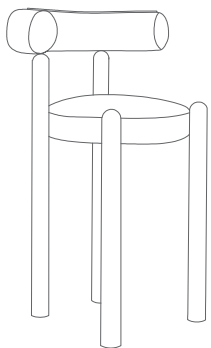

-64 CM-

-62 CM-

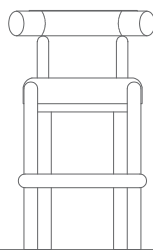

-64 CM-

-104.5 CM-

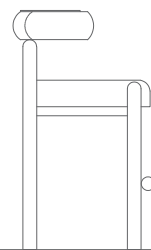

-62 CM-

Catalog product-fabric

N-A20/Boucle



02

Alternative fabric
Linen, Linen teddy, Boucle and Suede

Catalog product-Legs

Cappuccino Painted Metal





A NEUTRAL LIVING ROOM WITH
THE COMFORT THAT YOU NEED.





YUI TABLE

TECHNICAL SPECIFICATIONS

TABLE TOP WOOD LAQUER PAINT-SILK MAT
 PORCELAIN CERAMIC CALACATTA MICHELANGELO

LEGS METAL



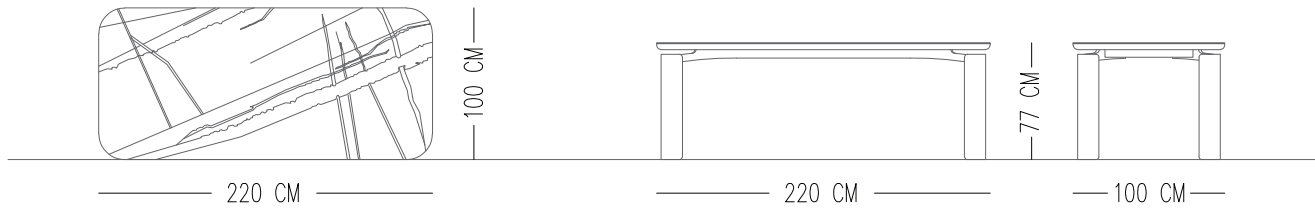

Catalog product

Top/Under
 Laquer painted wood-Soft touch-silk mat
 under porcelain ceramic



Catalog product

Porcelain Ceramic-Calacatta
 Michelangelo-polish



Legs
 Lacquer Painted on Wood-Soft touch



Alternative material
 All porcelain ceramic,marble,laquer paint,oakwood
 veneering



YUI TABLE

TECHNICAL SPECIFICATIONS

TABLE TOP WOOD LAQUER PAINT-SILK MAT
 PORCELAIN CERAMIC CALACATTA MICHELANGELO

LEGS METAL



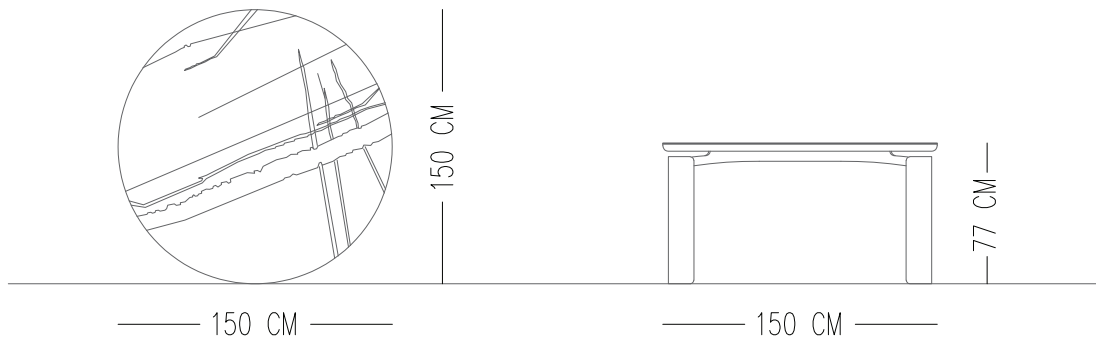

Catalog product

Top
Lacquer Painted on wood (matt)-Cinnamon-silk mat



Catalog product

Porcelain Ceramic-Calacatta
Michelangelo-polish



Legs
Lacquer Painted on Wood-Soft touch



Alternative material
All porcelain ceramic,marble,lacquer paint,oakwood
veneering



MARLON ROUND TABLE

TECHNICAL SPECIFICATIONS

TOP/MARBLE

LEG:LAQUER PAINTED ON WOOD MATT SOFT TOUCH AND BRASS METAL FINISH

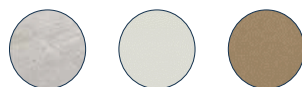

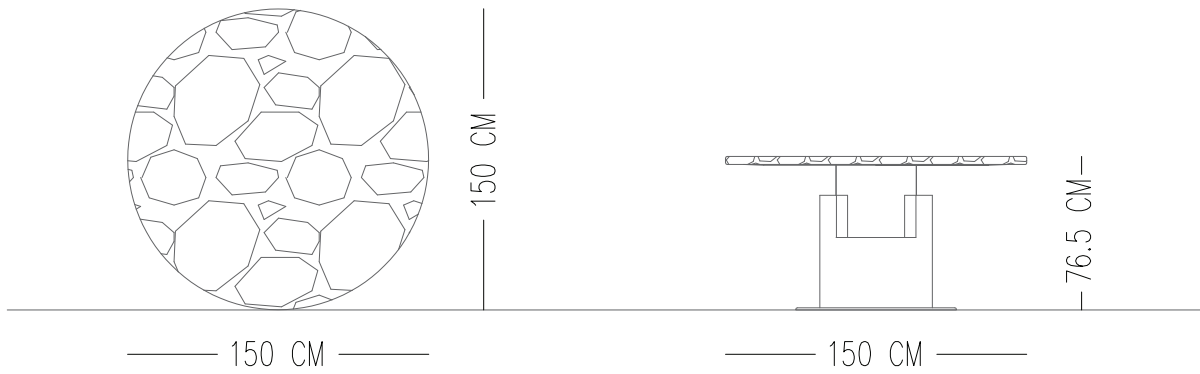

Catalog product

Top
Elegant Beige 3 Honed marble



Alternative material
All Marble
All Lacquer painted on wood (matt)

Catalog product

Legs
Lacquer painted on wood (matt) soft touch



Painted metal 04 Brass metal
finish on wood

Alternative material
All Lacquer painted on wood (matt)
Laquer painted on wood (matt) all ral color
All metal finishes on wood



ATHENA TABLE

TECHNICAL SPECIFICATIONS

STRUCTURE

OAK VENEERING, WITH BLACK MATT VARNISH



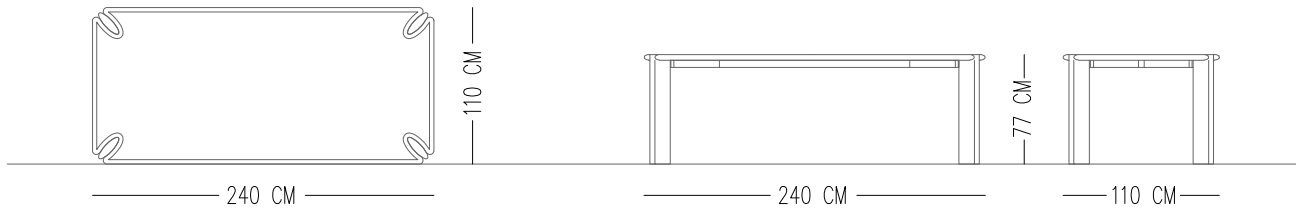

Catalog product

Top
Oak veneering with black matt varnish
With rose shine



Alternative material
All Wood Veneering
Material Cataloge

Catalog product

Legs
Oak veneering with black matt varnish
With rose shine



Alternative material
All Wood Veneering
Material Cataloge



ASTRA ROUND TABLE

TECHNICAL SPECIFICATIONS

STRUCTURE

TOP: NATURAL STONE
BASE: NATURAL WOOD



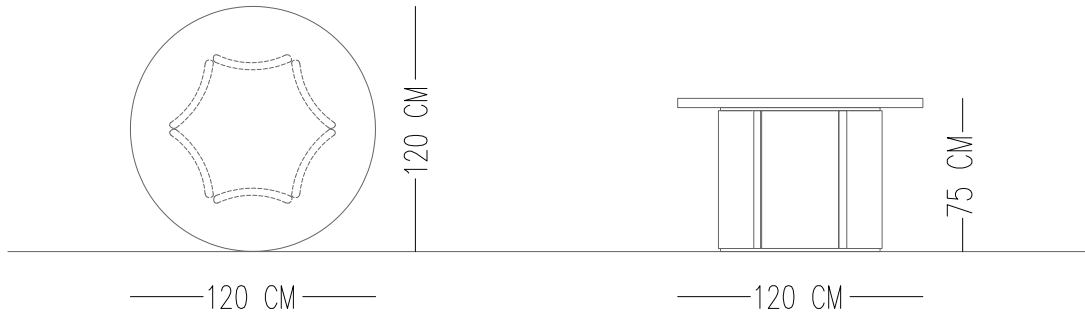

Catalog product

Top
Natural stone



Catalog product

Legs
Natural wood



Alternative material

Legs are natural wood painted black



LOTUS ROTATING TABLE

TECHNICAL SPECIFICATIONS

TABLE TOP PORCELAIN CERAMIC
LEGS WOOD PAINTED BRONZE BROWN AND BRASS METAL DETAIL



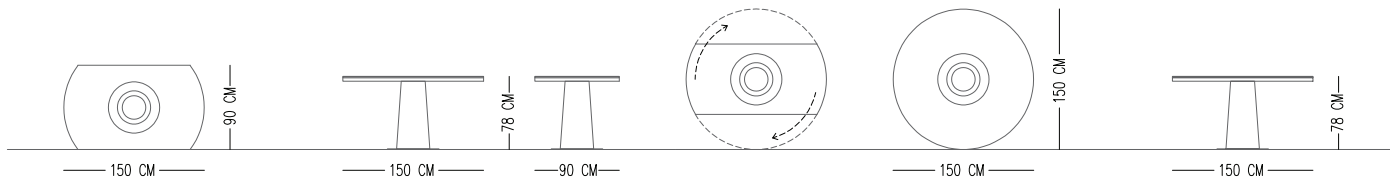

Catalog product

Top



Porcelain Ceramic

Alternative material

All marble, porcelain ceramic in Norde material catalogue.

Legs: All painted metal

Catalog product

Legs

Painted metal-black, Painted metal 04 Brass metal





MARLON TABLE

TECHNICALS PECIFICATIONS

TOP ELEGANT BEIGE MARBLE

LEGS SPECIAL PAINT FINISH ON MDF



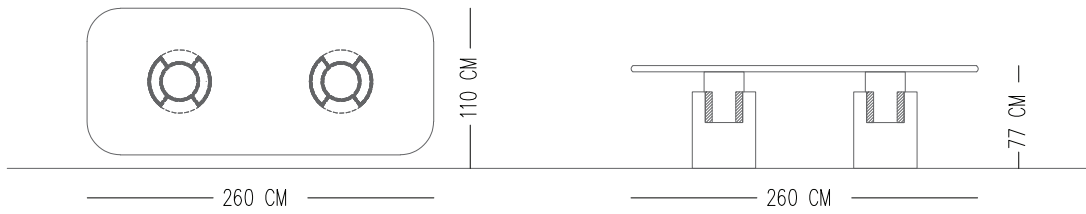
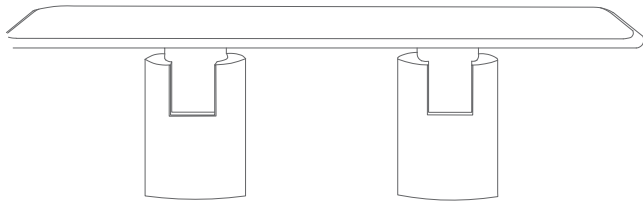

Catalog product

Top
Elegant Beige 3 Honed marble



Alternative material
All Marble
All Laquer painted on wood (matt)

Catalog product

Legs



Lacquer painted on wood (matt) special
Painted metal 04 Aged Brass metal finish on wood

Alternative material
All Lacquer painted on wood (matt)
Lacquer painted on wood (matt) all ral color
All metal finishes on wood



CLEMENTINE TABLE

TECHNICAL SPECIFICATIONS

TOP	BRONZE GLASS
LEGS	NATURAL OAK VENEERING WITH PAINT FINISH

TABLE TOP MATERIAL VARIATION : BRONZE, SMOKED, CLEAR GLASS ALTERNATIVES
LEGS MATERIAL VARIATION : NATURAL WOOD FINISH / REQUESTED LAQUER PAINT FINISH



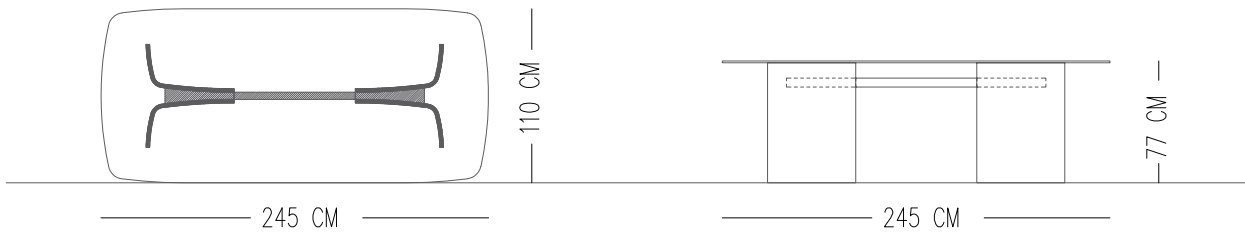
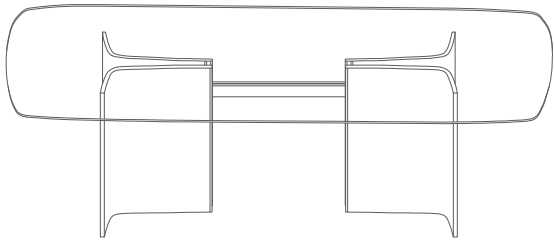

Catalog product

Top
Bronze glass 6mm+6mm tempered glass



Catalog product

Legs
Oak Veneering with Natural Varnish&chromium



Alternative material
All glass and painted glass
All Oak Veneering
All wood Lacquer painted

Alternative material
All Oak Veneering
All wood Laquer painted
Lacquer painted on wood (matt)



AUDREY TABLE

TECHNICAL SPECIFICATIONS

TOP PAINTED GLASS WITH MDF BACKING



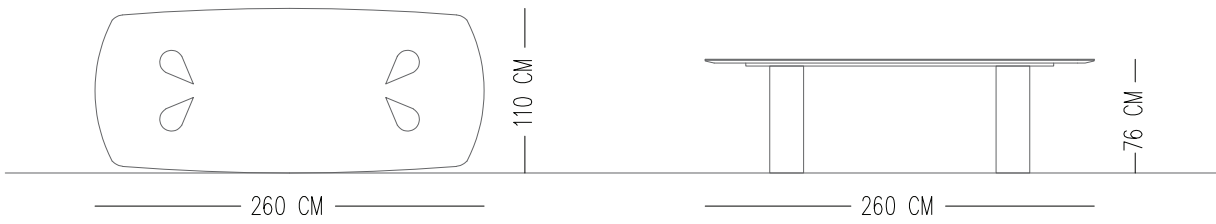
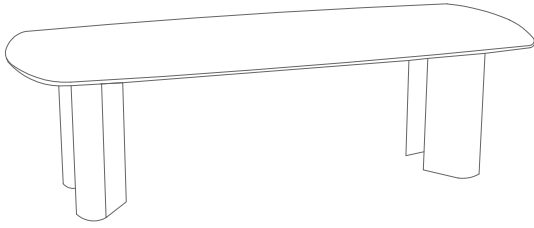

Catalog product

Top
Porcelain Ceramic Fokos Sale



Alternative material
All Porcelain Ceramic
All oak wood Veneering
All wood Laquer painted

Catalog product

Legs
Painted metal finish



Alternative material
All metal finishes on wood



PIETRA TABLE

TECHNICALS PECIFICATIONS

TABLE TOP FINISH

SANDBLASTED OAK WOOD VENEERING WITH BLACK VARNISH

TABLE TOP MATERIAL VARIATION : OAK WOOD VENEERING FINISHES IN NORDE MATERIAL CATALOGUE



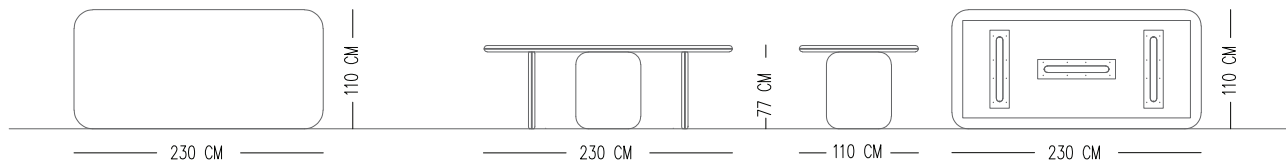
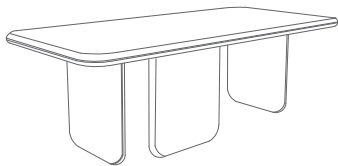

Catalog product

Table top material
Sandblasted oak wood veneering with black Varnish



Alternative material
All Oak wood Veneering

**If Natural oak is chosen, the color may be different from the edge wood

Catalog product

Legs
Laquer painted on wood (matt) black



Alternative material
All Oak wood Veneering
All Wood Laquer paint
with Table top finish

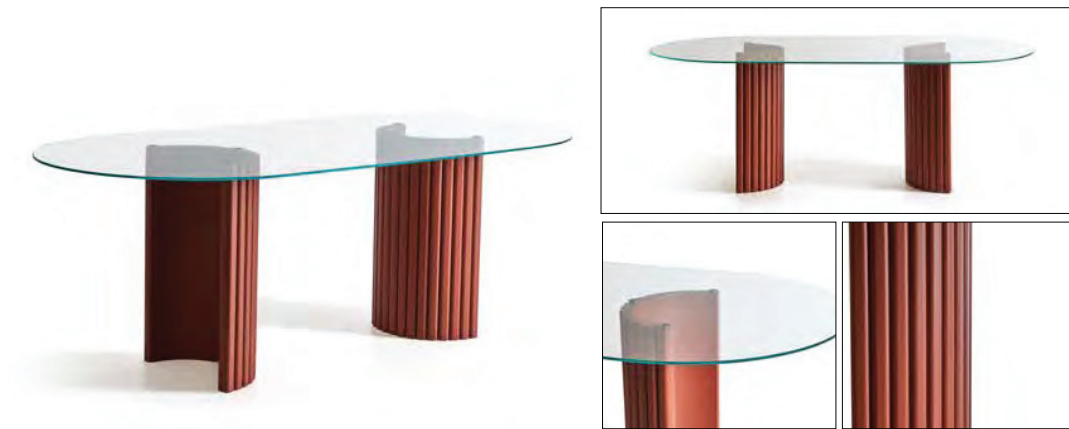

OLIVER TABLE

TECHNICAL SPECIFICATIONS

TOP CLEAR GLASS

TABLE TOP MATERIAL VARIATION : ALL GLASS AND WOOD FINISHES IN NORDE MATERIAL CATALOGUE



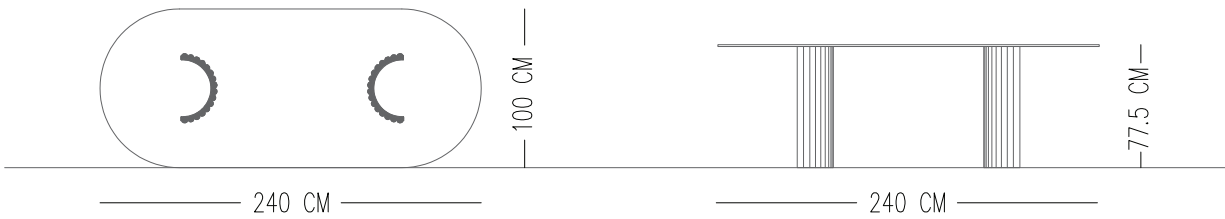
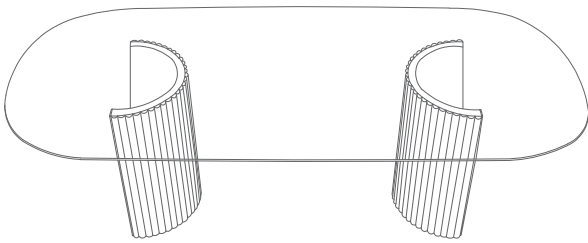

Catalog product

Table top material
Clear glass



Catalog product

Legs
Laquer painted on oak veneering(matt) Terracota





COSTA TABLE

TECHNICAL SPECIFICATIONS

TABLE TOP FINISH

ICEBERG MARBLE

TABLE TOP MATERIAL VARIATION : ALL CERAMIC, MARBLE AND WOOD FINISHES IN NORDE MATERIAL CATALOGUE



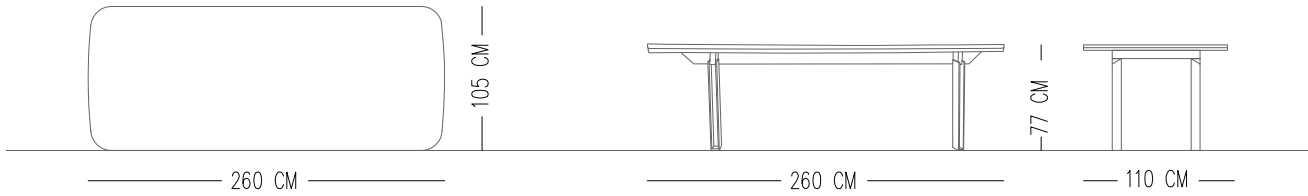
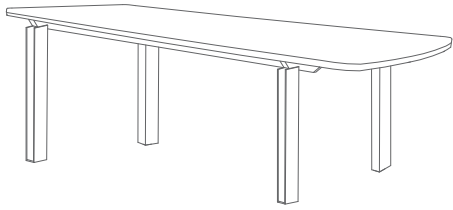

Catalog product

Table top material
Iceberg Marble Honed with MDF



Alternative material
All marble
All Porcelain ceramic

Catalog product

Legs
Painted metal 04 Aged Brass metal finish



Painted metal 4 Black with aged brass details

Alternative material
All metal finishes



PATMOS TABLE

TECHNICAL SPECIFICATIONS

TABLE TOP FINISH

MARBLE OR PORCELAIN CERAMIC

TABLE TOP MATERIAL VARIATION : ALL MARBLE & PORCELAIN CERAMIC FINISHES IN NORDE MATERIAL CATALOGUE



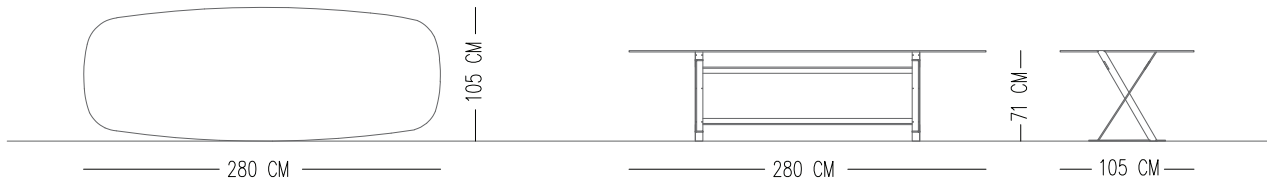
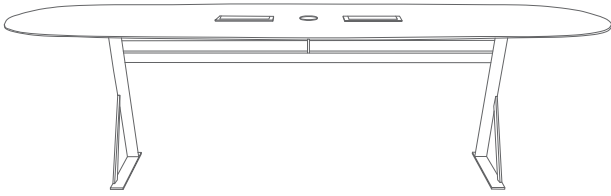

Catalog product

Table top material
Alexander Black marble polished



Alternative material
All marble
All Porcelain ceramic

Catalog product

Legs
Painted metal 4 Black



Alternative material
All metal finishes



GENEROUS PROPORTIONS, MADE OF THE
FINEST MATERIALS AND RICH IN DETAILS.





YUI SIDEBOARD

TECHNICAL SPECIFICATIONS

- 1 STRUCTURE/OAK WOOD LAQUER PAINTED-SILK MAT
- 2 STRUCTURE/OAK WOOD LAQUER PAINTED-SILK MAT
- 3 GLASS-PUSH OPEN CABINET DOOR AND SHELF
- 4 PORCELAIN CERAMIC



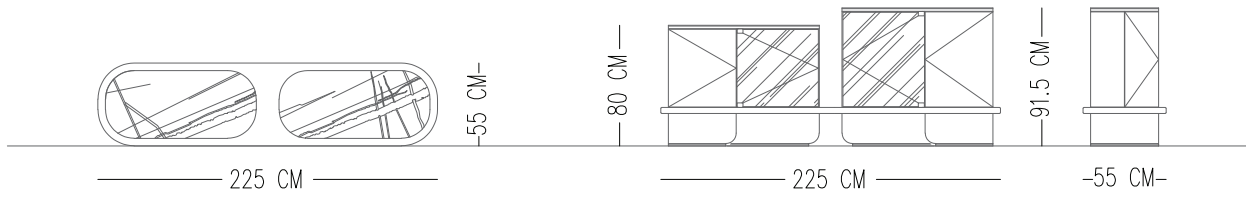

Catalog product

Structure
Lacquer Painted on Wood
Soft touch



Structure Line
Lacquer Painted On Wood (Matt)
Cinnamon



Cover/Shelf
Bronze Glass



Top Material
Porcelain Ceramic-Calacatta
Michelangelo-polish





ORBIT SIDEBOARD

TECHNICAL SPECIFICATIONS

STRUCTURE SANDBLASTED OAKWOOD VENEERING WITH BLACK POLISH VARNISH
SMOKED GLASS-6 MM CABINET DOOR
SATIN BRASS PAINTED METAL HANDLE
AND SYLINDER ROD BLACK GLASS HINGE PROFILE



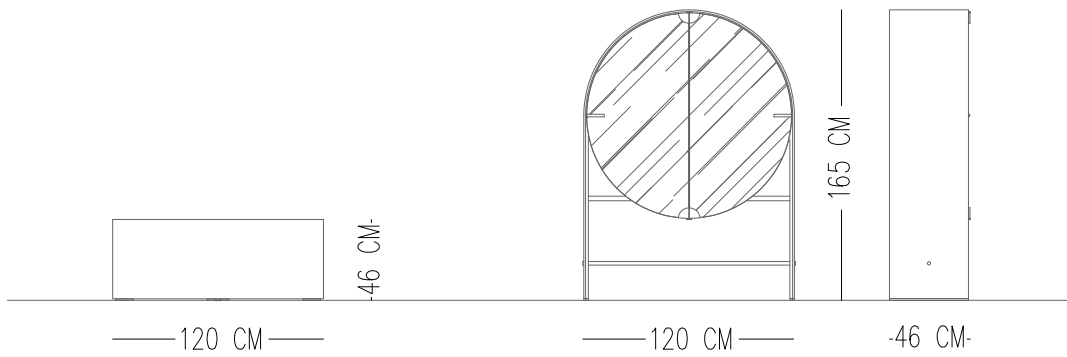

Catalog product

Structure
Sandblasted Oakwood
Veneering



Black Polish Varnish

Textured
Glass



Metal
Satine brass
painted



Glass
Black





CIRCLE SIDEBOARD

TECHNICAL SPECIFICATIONS

CIRCLE COVER: FRONT OF MATERIAL CORK INNER SHELVES 6 MM GLASS

SHELVES: INNER SHELVES 6 MM GLASS

BASE: WOOD LAQUER PAINTED-SILK MAT



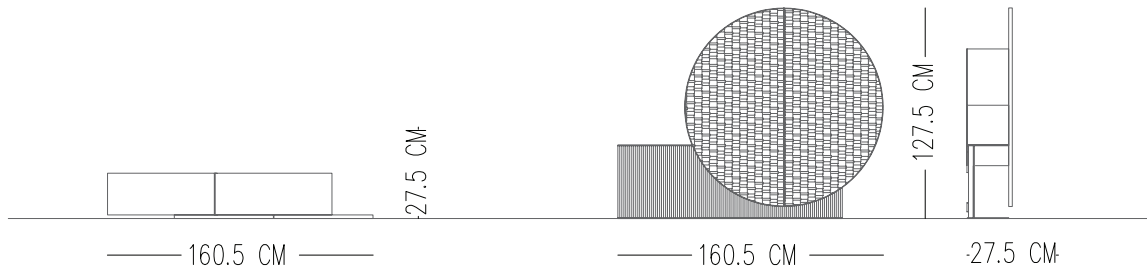

Catalog product

Cork material



Oak wood veneering



Metal
Black





ATHENA SIDEBOARD

TECHNICAL SPECIFICATIONS

BASE: SANDBLASTED OAKWOOD VENEERING WITH BLACK VARNISH
CABINET DOORS: FABRIC COVERED CABINET DOORS
METAL DETAIL WOOD LEGS



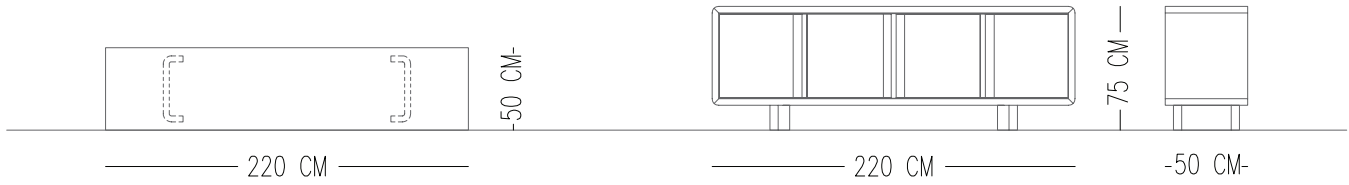

Catalog product

Wood 04
Oak Veneering with
Black matt varnish-sandblasted
detail



N-A15 /Nubuk



015

Catalog product legs

Wood 04
Oak Veneering with
Black matt varnish-sandblasted
detail





CLEMENTINE SIDEBOARD

TECHNICAL SPECIFICATIONS

STRUCTURE NATURAL OAK VENEERING WITH PAINT FINISH



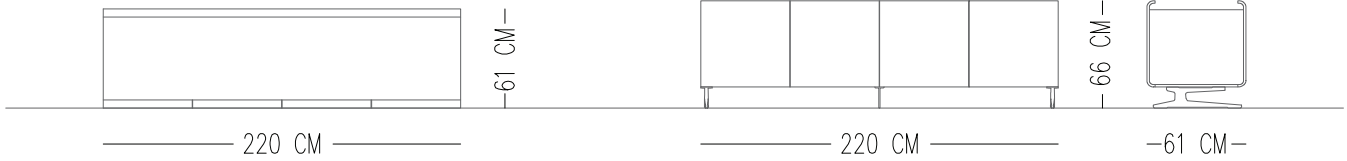
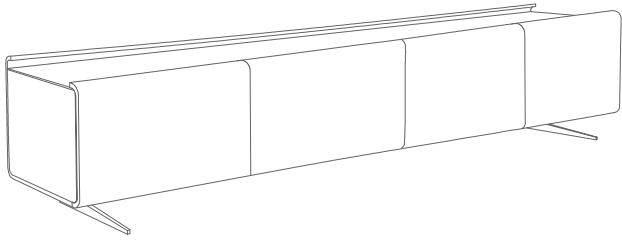

Catalog product

Structure
Oak Wood Veneering with Laquer Painted on wood
(matt) cappuccino



Top/Porcelain Ceramic
Calacatta



Catalog product

Legs
Painted metal 4 Black



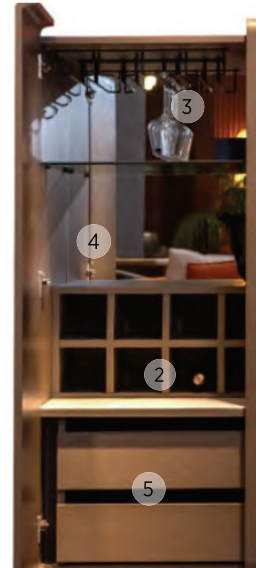

- 1 BACK OF CABINET INTERIOR - MIRROR
- 2 CERAMIC SHELF
- 3 METAL GOBLET UNIT
- 4 GLASS SHELF
- 5 STRUCTURE & DRAWER & BOTTLE HOLDER

CLEMENTINE SIDEBOARD

TECHNICAL SPECIFICATIONS

STRUCTURE OAK WOOD VENEERING WITH LAQUER PAINTED ON WOOD

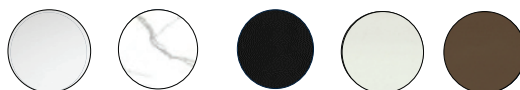

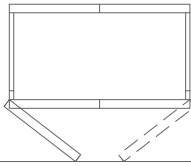
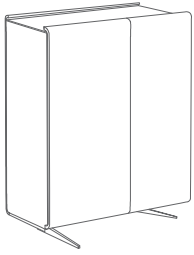

— 105 CM —

-60.5 CM-

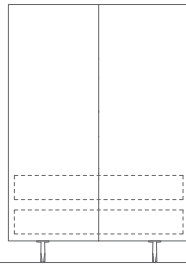

— 105 CM —

150 CM

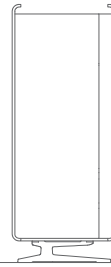

-60.5 CM-

Catalog product

Structure
Oak Wood Veneering with Lacquer Painted
on wood (matt) cappuccino



Alternative material

Cabinet interior back
Clear mirror



Alternative material

Glass shelf
Clear glass



Alternative material

Shelf
Porcelain Ceramic-Calacatta



Alternative material
All porcelain ceramic

Goblet unit
Painted metal 4 Black



Alternative material

Legs
Painted metal 4 Black



Alternative material



AUDREY SIDEBOARD

TECHNICAL SPECIFICATIONS

STRUCTURE NATURAL OAK VENEERING WITH PAINT FINISH



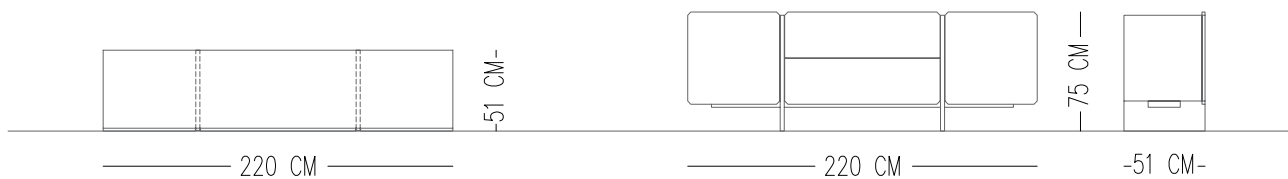
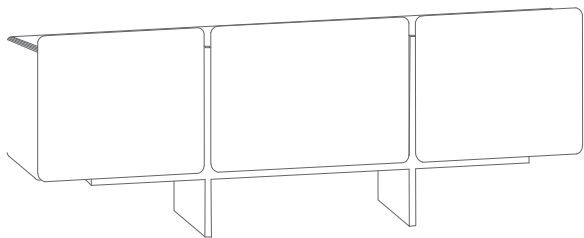

Catalog product

Structure
Oak Wood Veneering with Lacquer Painted on wood
(matt) terracotta



Catalog product

Legs
Oak Wood Veneering with Lacquer painted on wood
(matt) black



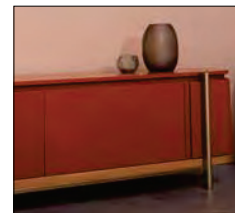

OLIVER SIDEBOARD

TECHNICAL SPECIFICATIONS

STRUCTURE LAQUER PAINT ON WOOD (TERRACOTA)
NATURAL OAK VENEERING WITH NATURAL FINISH

MIRROR SMOKED MIRROR



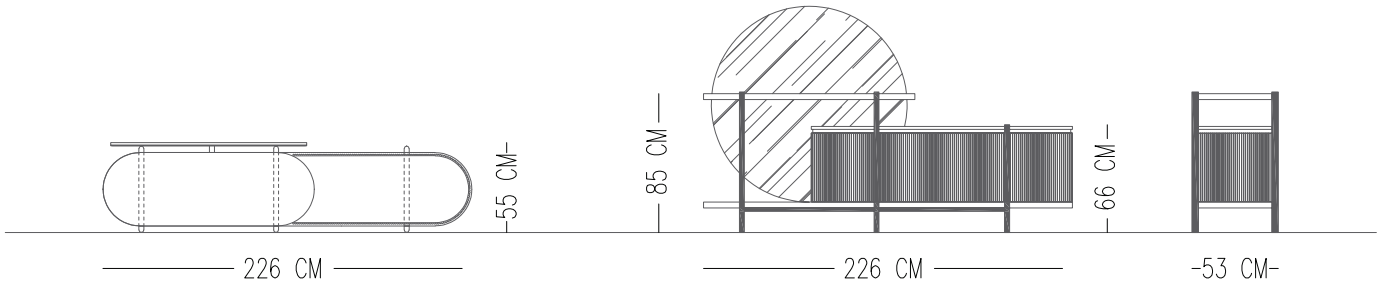
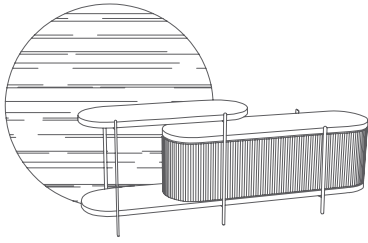

Catalog product

Structure
Oak Wood Veneering with Lacquer Painted on wood (matt) terracotta

Oak Wood Veneering with natural varnish



Catalog product

Legs
Painted metal O4 aged brass metal finish



Mirror
Smoked mirror



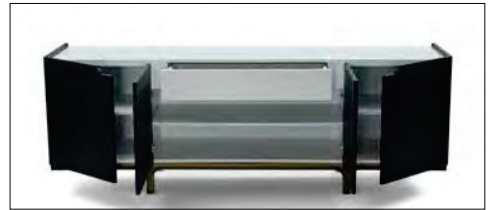

COSTA SIDEBOARD

TECHNICAL SPECIFICATIONS

STRUCTURE SANDBLASTED OAK WOOD VENEERING WITH BLACK VARNISH
LAQUER PAINTED ON WOOD (WHITE)

TOP PORCELAIN CERAMIC



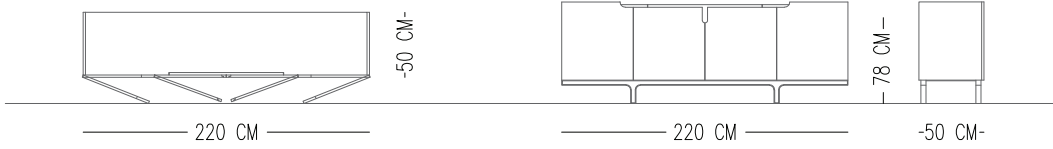
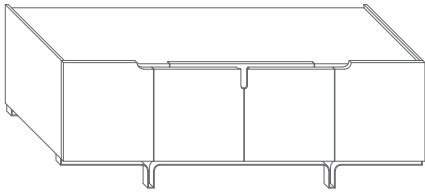

Catalog product

Structure
Oak Wood Veneering with black varnish



Top/Porcelain Ceramic Calacatta



Catalog product

Legs
Painted metal 04 Aged Brass metal finish





PIETRA SIDEBOARD

TECHNICAL SPECIFICATIONS

STRUCTURE SANDBLASTED OAK WOOD VENEERING WITH BLACK VARNISH

HANDLES BLACK METAL WITH BRASS AGING DETAIL. CABINET DOORS: HAZERAN FINISH

MATERIAL VARIATION : OAK WOOD VENEERING FINISHES IN NORDE MATERIAL CATALOGUE



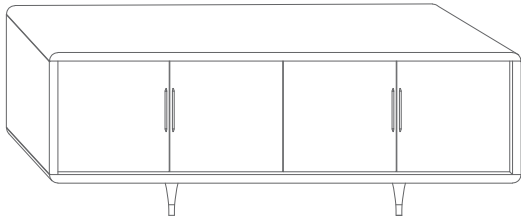

Catalog product

Structure
Sandblasted Oak Wood Veneering with black varnish



Catalog product

Legs
Oak wood black varnish with with painted metal O4
aged brass metal finish



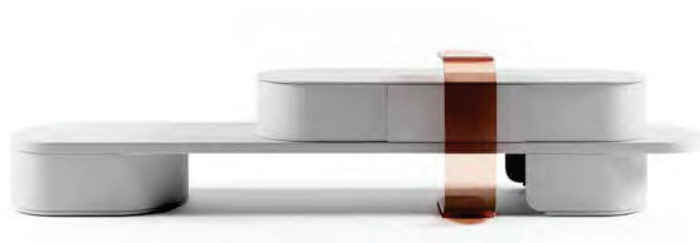

YUI TV UNIT

TECHNICAL SPECIFICATIONS

- 1 STRUCTURE/OAK WOOD LAQUER PAINTED-SILK MAT
- 2 PLEXY
- 3 METAL SHELF UNIT

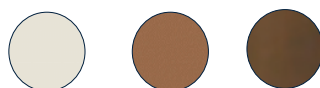

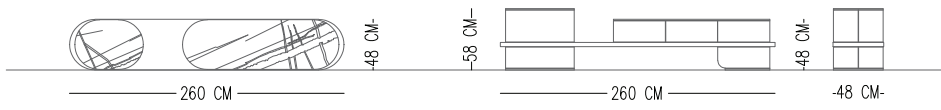

MODULES

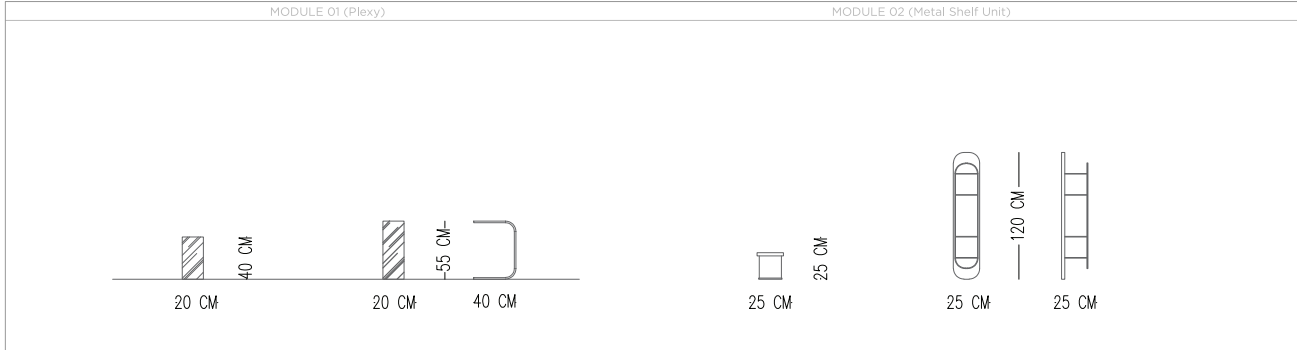

Catalog product

Structure
Lacquer Painted on Wood
Soft touch



Catalog product

Metal Shelf Unit
Cinnamon



Plexy
Cinnamon



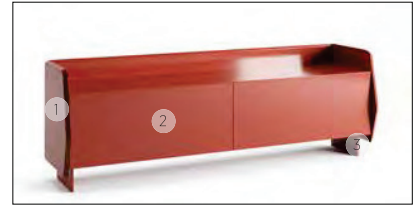

VOUGE TV UNIT

TECHNICAL SPECIFICATIONS

- 1 STRUCTURE/OAK WOOD LAQUER PAINTED-POLISH
- 2 STRUCTURE/OAK WOOD LAQUER PAINTED-POLISH FALLS COVER
- 3 LEGS /OAK WOOD LAQUER PAINTED-POLISH



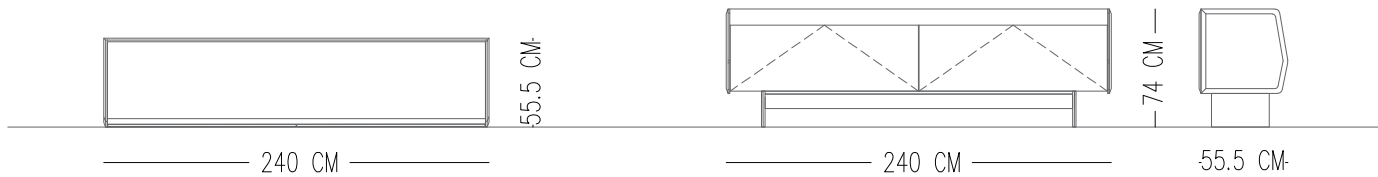

Catalog product

Structure
Lacquer Painted on wood (gloss) RUBY



Catalog product

Legs
Lacquer Painted on wood (gloss) RUBY





AUDREY TV UNIT

TECHNICAL SPECIFICATIONS

TOP & STRUCTURE

OAK VENEERING ON MDF WITH SANDBLASTED FINISH



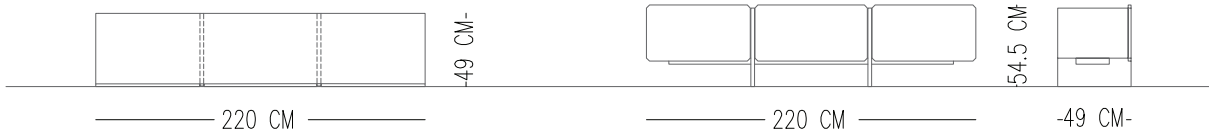
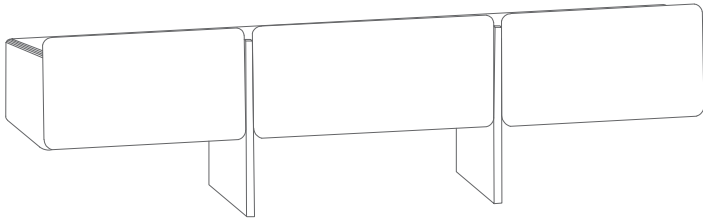

Catalog product

Structure
Oak Wood Veneering with Lacquer Painted on wood
(matt) terracotta



Catalog product

Legs
Oak Wood Veneering with Lacquer painted on wood
(matt) black





- 1 CABINET DOOR/ GLASS
- 2 CABINET DOOR/ LACQUER PAINTED WOOD
- 3 CABINET DOOR/ GLASS

RITA TV UNIT

TECHNICAL SPECIFICATIONS

STRUCTURE

NATURAL OAK VENEERING ON WOOD WITH NATURAL VARNISH
LACQUER PAINTED WOOD
PLEXYGlass LIGHTBOX VERTICAL ELEMENTS
CLEAR GLASS CABINET DOOR

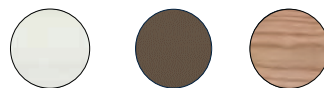

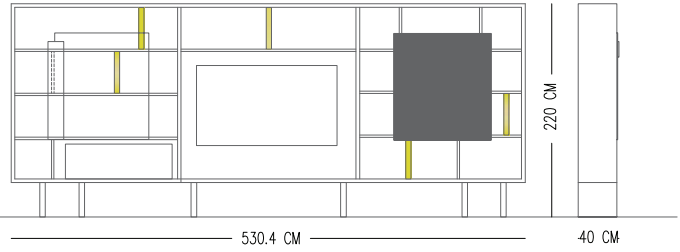
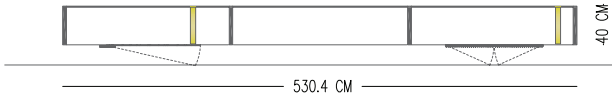
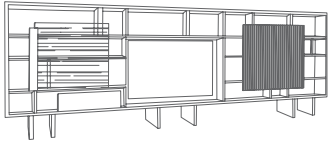

Catalog product

Structure
Oak Wood Veneering with natural varnish



Cabinet door
Lacquer painted wood (matt) cappuccino



Cabinet door
Clear Glass





OLIVER TV UNIT

TECHNICAL SPECIFICATIONS

STRUCTURE LAQUER PAINT ON WOOD (TERRACOTA)
 NATURAL OAK VENEERING WITH NATURAL FINISH

MATERIAL VARIATION: OAK WOOD VENEERING FINISHES IN NORDE MATERIAL CATALOGUE
 ALL LACQUER FINISHES IN NORDE MATERIAL CATALOGUE



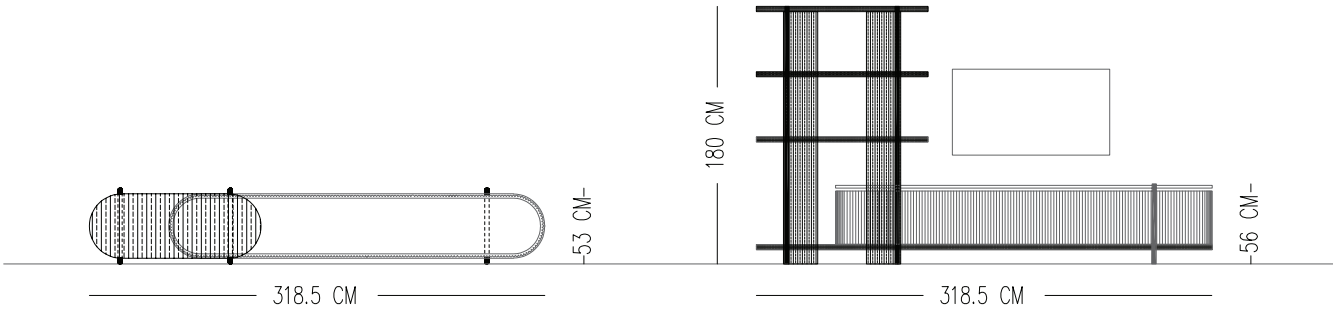
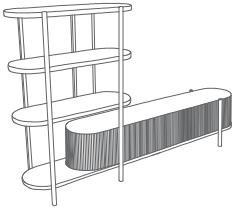

Catalog product

Structure
Oak Wood Veneering with Lacquer Painted on wood
(matt) terracotta

Oak Wood Veneering with natural varnish



Catalog product

Legs
Painted metal O4 aged brass
metal finish



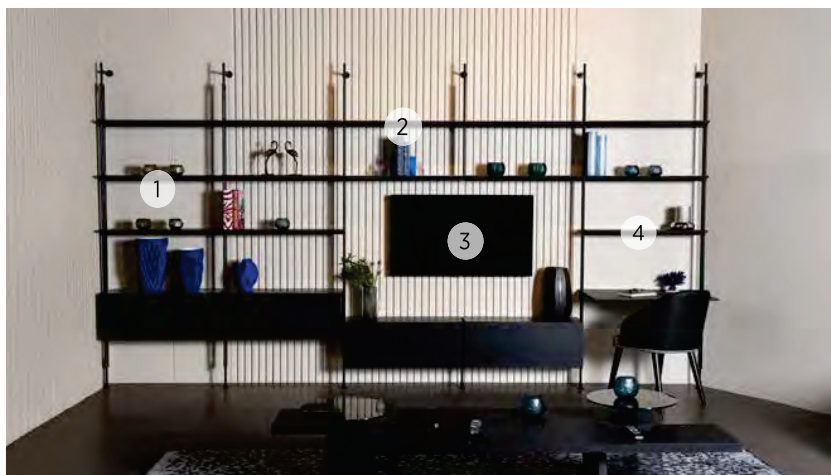

- 1 LARGE SHELF UNIT
- 2 NARROW SHELF UNIT
- 3 TV&SHELF UNIT
- 4 WORKING TABLE &SHELF

MARLON TV UNIT & BOOKSHELF

TECHNICAL SPECIFICATIONS

STRUCTURE

OAK VENEERING ON MDF WITH SANDBLASTED BLACK PAINT
BLACK PAINTED METAL PROFILES



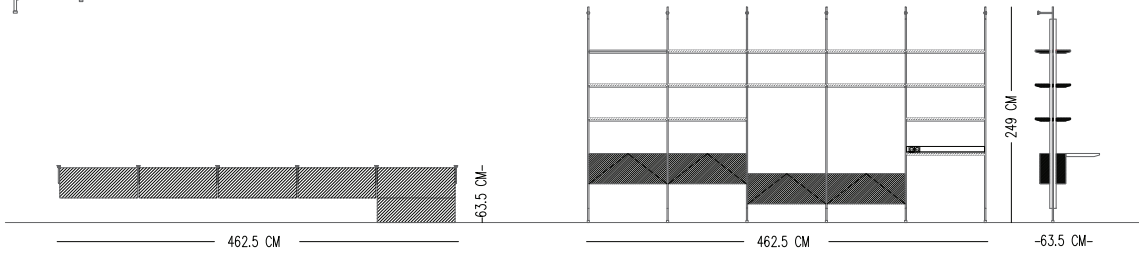
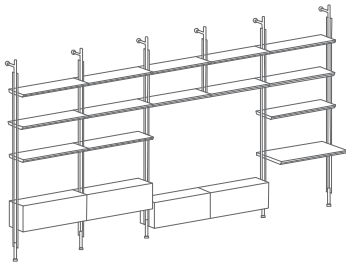

MATERIAL VARIATION : ALL WOOD VENEERING FINISHES IN NORDE MATERIAL CATALOGUE

MODULATION CONSIST OF 3 DIFFERENT FUNCTIONS ALL MODULES CAN BE CONNECTED WITH EACH OTHER

- 1- BUFFET
- 2- TV
- 3- STUDY DESK

Catalog product

Structure
Sanded oak wood veneering with black



Catalog product

Legs
Painted metal 04



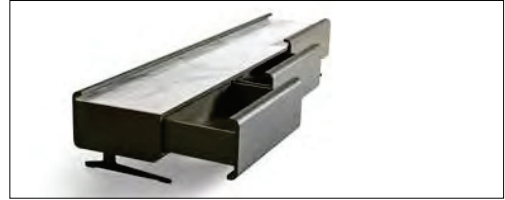

CLEMENTINE TV UNIT

TECHNICAL SPECIFICATIONS

TOP
STRUCTURE

CERAMIC FINISH (OPTIONAL)
NATURAL OAK VENEERING (MATT POLISHED)



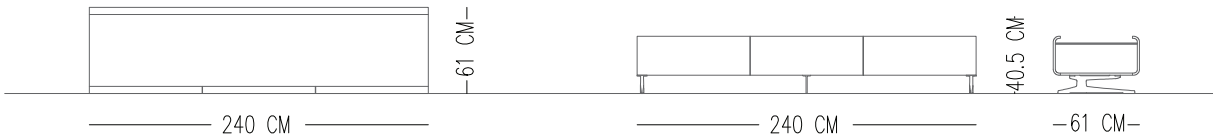
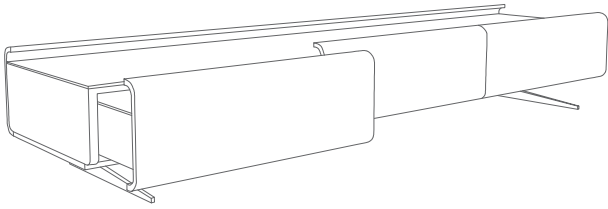

Catalog product

Structure
Oak Wood Veneering with Lacquer Painted on wood
(matt) cappuccino



Top/Porcelain Ceramic
Calacatta



Catalog product

Legs
Painted metal 4 Black



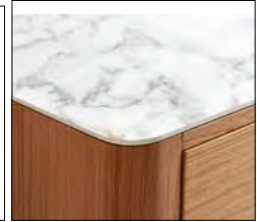

MOJO TV UNIT

TECHNICAL SPECIFICATIONS

TOP & STRUCTURE

NATURAL OAK VENEERING (MATT POLISHED)



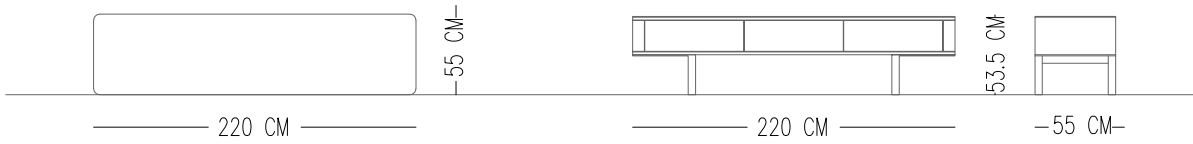
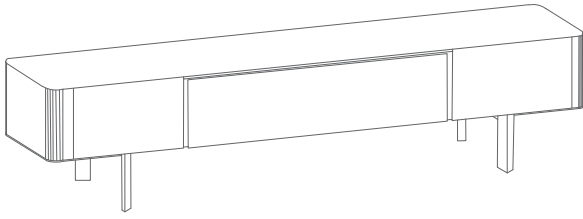

Catalog product

Structure
Structure/Oak Wood Veneering with natural varnish



Top/Porcelain Ceramic
Calacatta



Catalog product

Legs
Painted metal 2 Cappuccino RAL 7006





YUI CONSOLE TABLE

TECHNICAL SPECIFICATIONS

TOP: PORCELAIN CERAMIC-5 MM
OAK WOOD LAQUER PAINTED (INSIDE DIFFERENT COLOR) SILK MAT



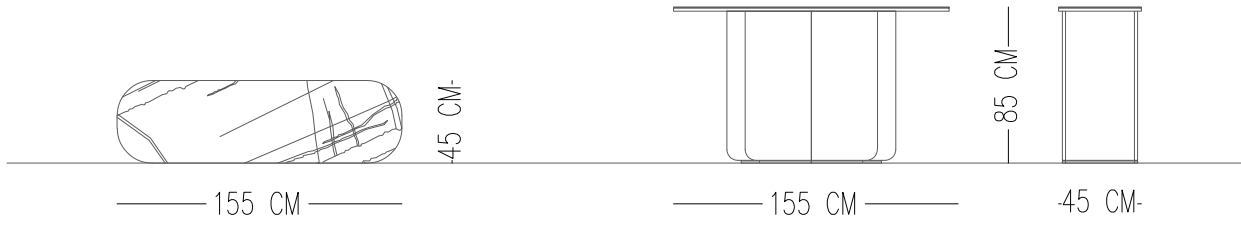

Catalog product

Leg
Lacquer Painted on Wood
Soft touch



Catalog product

Leg Inside
Lacquer Painted On Wood
(Matt) Cinnamon



Top Material
Porcelain Ceramic Calacatta
Michelangelo Polish





OLIVER CONSOLE TABLE

TECHNICAL SPECIFICATIONS

TOP: TEXTURED BRONZE GLASS
BASE, OAK WOOD VENEERING NATURAL
OPENINGS ARE OAK WOOD VENEERING LAQUER PAINT CINNAMON
LEGS: SILVER METAL



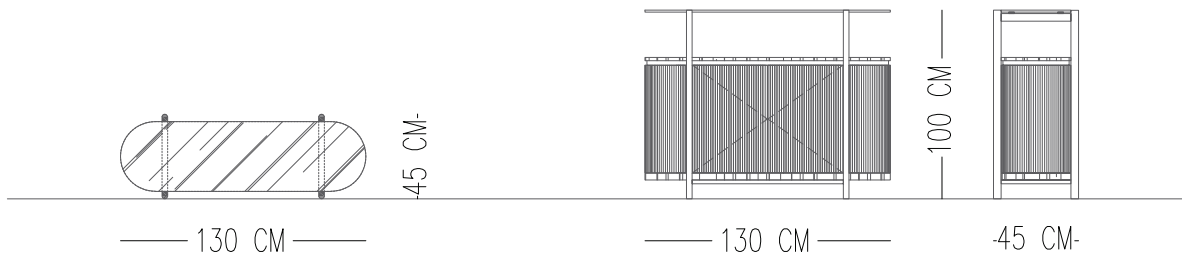

Catalog product

Glass
Textured glass



Catalog product

Base
Oak wood veneering
natural



Openings
material
Laquer paint
Cinnamon



Legs
Silver metal





MONA CONSOLE TABLE

TECHNICAL SPECIFICATIONS

SHELVES: OAK WOOD VENEERING WITH NATURAL VARNISH
LEGS: BLACK METAL



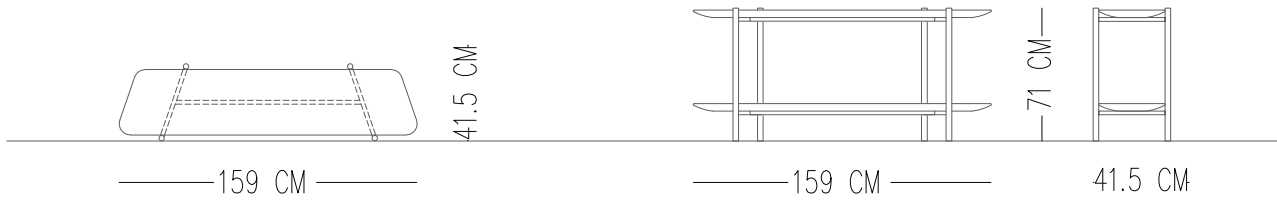

Catalog product

Shelves
Oak wood veneering
natural



Catalog product

Legs
Black metal





DOMINO CONSOLE TABLE

TECHNICAL SPECIFICATIONS

STRUCTURE

TOP: CALACATA MICHELANGELO

BASE: SANDBLASTED OAKWOOD VENEERING WITH BLACK POLISH VARNISH

SIDE- EDGE-METAL



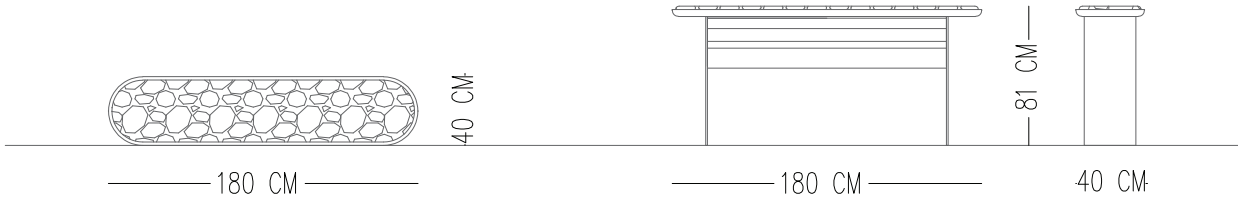

Catalog product
 Top
 Porcelain ceramic
 Calacatta



Sandblasted Oakwood Veneering
 Black Polish Varnish



Metal
 Painted metal black





ASTRA CONSOLE TABLE

TECHNICAL SPECIFICATIONS

INTERIOR STRUCTURE

TOP IS NATURE STONE
LEGS ARE NATURAL WOOD



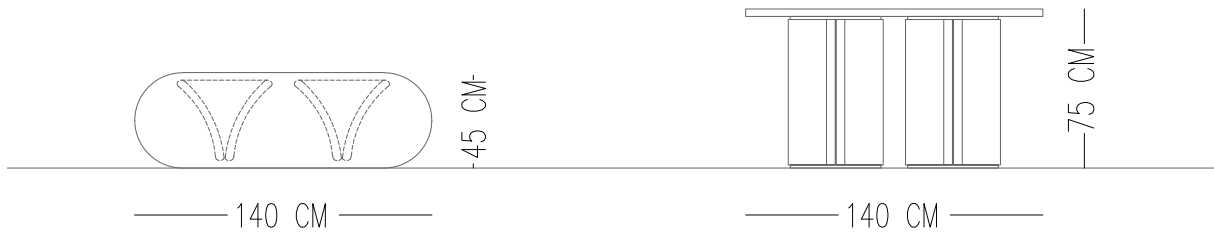

Catalog product
Natural stone



Leg
Natural wood



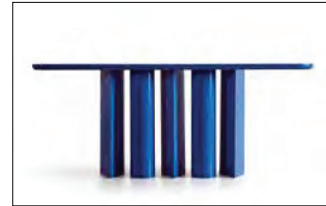

AUDREY CONSOLE TABLE

TECHNICAL SPECIFICATIONS

TOP

LAQUER PAINT ON WOOD (VIOLET BLUE)

MATERIAL VARIATION: ALL LAQUER FINISHES IN NORDE MATERIAL CATALOGUE



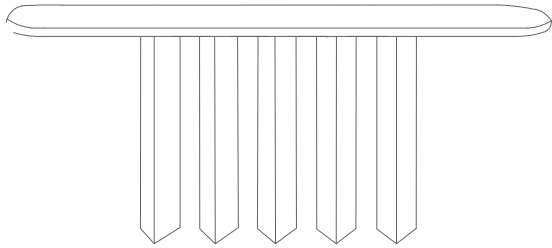

Catalog product

Top
Lacquer Painted on wood (matt) violet blue



Catalog product

Legs
Painted metal (matt) violet blue





PIETRA CONSOLE TABLE

TECHNICAL SPECIFICATIONS

TABLE TOP FINISH

SANDBLASTED OAK WOOD VENEERING WITH BLACK VARNISH



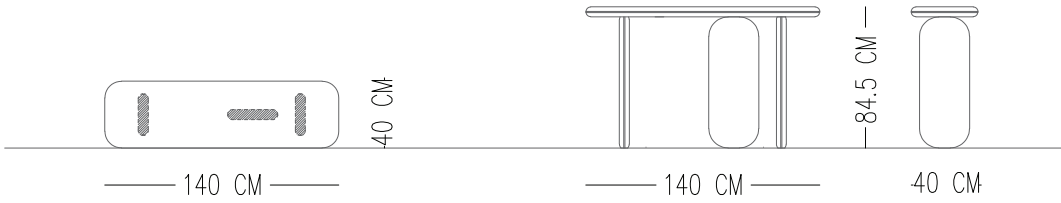

Catalog product

Top
Sandblasted Oak Wood Veneering with black Varnish



Catalog product

Legs
Sandblasted Oak Wood Veneering with black Varnish





ETERNA BOOKCASE

TECHNICAL SPECIFICATIONS

- 1 BASE/FABRIC COVERED OAK WOOD
- 2 OAK WOOD LAQUER PAINTED SHELVES WITH METAL INSIDE
- 3 METAL PROFILE

SANDBLASTED OAK WOOD VENEERING WITH VARNISH COLOR
METAL IN SANDBLASTED OAK WOOD



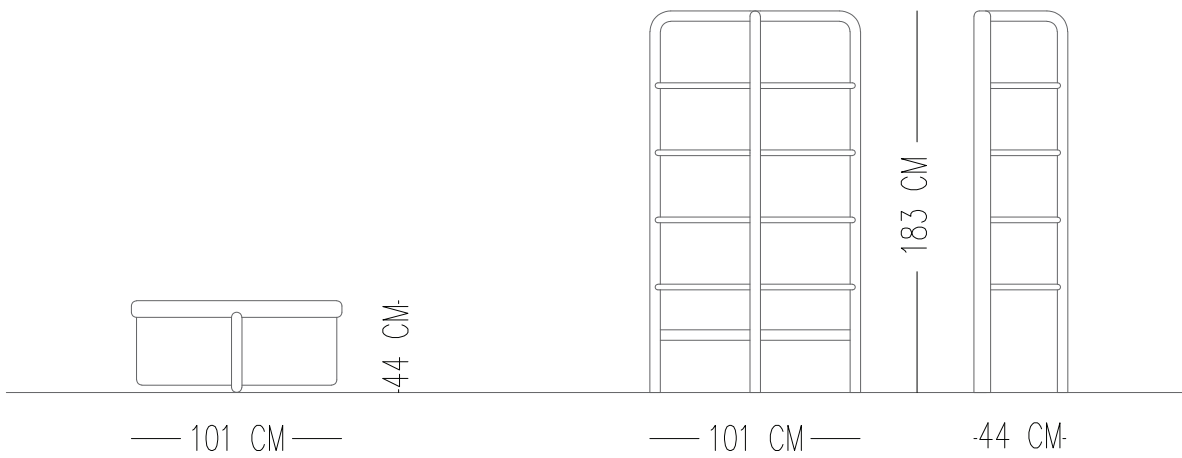

Catalog product

Fabric
N-C54/Linen
08



Catalog product

Wood
Lacquer Painted on Wood





VIBE POUF

TECHNICAL SPECIFICATIONS

INTERIOR STRUCTURE

SOLID WOOD and ELASTIC COLUMN

SEAT CUSHION

HIGH RESILIENT FOAM

UPHOLSTERY

TIGHT



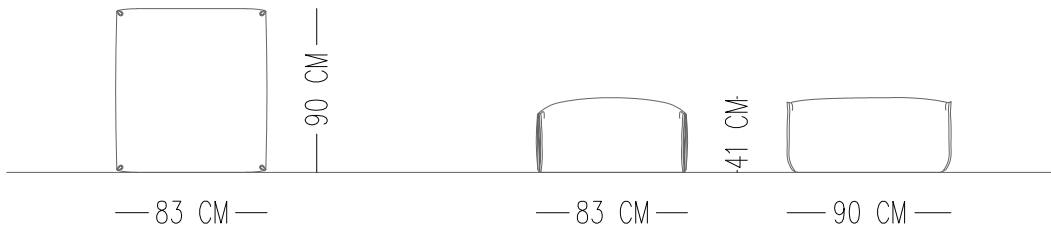

Catalog product-fabric

N-B28/Boucle



11

Catalog product-Legs

Hidden Leg



TRIO POUF

TECHNICAL SPECIFICATIONS

INTERIOR STRUCTURE

SOLID WOOD and ELASTIC COLUMN

SEAT CUSHION

HIGH RESILIENT FOAM

UPHOLSTERY

TIGHT



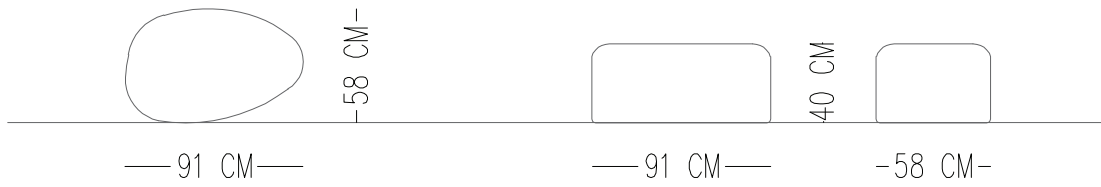

Catalog product-fabric

NB -33



Catalog product-Legs

Hidden Leg



DOMINO POUF

TECHNICALS PECIFICATIONS

INTERIOR STRUCTURE SOLID WOOD, STEEL AND MDF WITH ZIGZAG BOW

SEAT CUSHION HIGH RESILIENT FOAM & DOWNTOP

BACK BACK CUSHION 100% DOWN/FEATHERS

UPHOLSTERY TIGHT



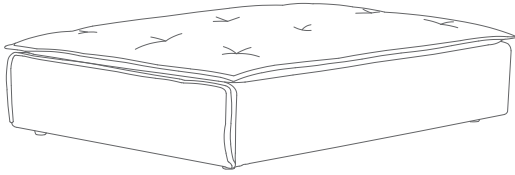

Catalog product-fabric

N-A10/Linen



43851

Catalog product-Legs

Hidden Leg



NORDEN POUF

TECHNICAL SPECIFICATIONS

INTERIOR STRUCTURE SOLID WOOD, STEEL AND MDF WITH ZIGZAG BOW

SEAT CUSHION HIGH RESILIENT FOAM & DOWNTOP

BACK BACK CUSHION 100% DOWN/FEATHERS

UPHOLSTERY TIGHT



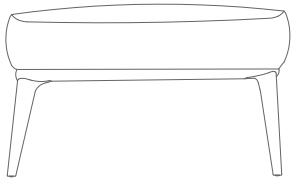

—70 CM—

—50 CM—

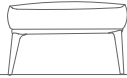

—70 CM—

—42 CM—



—50 CM—

Catalog product-fabric

N-D13/Linen



1002

Catalog product-Legs

Black Wood





NORA POUF

TECHNICALS PECIFICATIONS

INTERIOR STRUCTURE SOLID WOOD, STEEL AND MDF WITH ZIGZAG BOW

SEAT CUSHION HIGH RESILIENT FOAM & DOWNTOP

BACK BACK CUSHION 100% DOWN/FEATHERS

UPHOLSTERY TIGHT



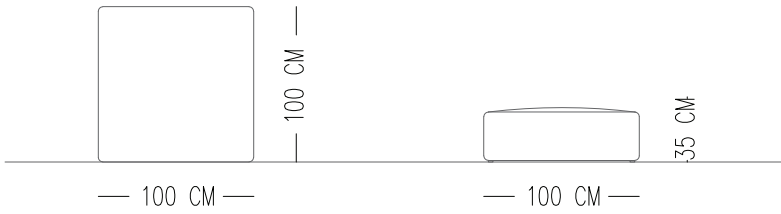
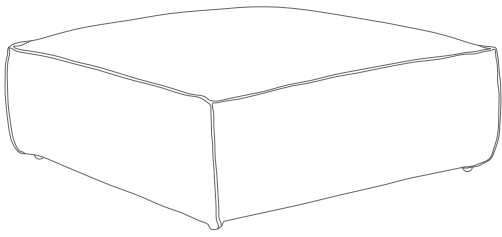

Catalog product-fabric

NB32



213-01

Catalog product-Legs

Hidden Leg



BEAR POUF

TECHNICAL SPECIFICATIONS

INTERIOR STRUCTURE

SOLID WOOD and ELASTIC COLUMN

SEAT CUSHION

HIGH RESILIENT FOAM

UPHOLSTERY

TIGHT



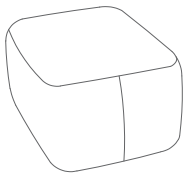

Catalog product-fabric

N-A16/Plush linen



44423

Catalog product-Legs

Hidden Leg



MARLON BENCH

TECHNICAL SPECIFICATIONS

INTERIOR STRUCTURE

SOLID WOOD & PAPEL AND ELASTIC COLUMN

SEAT CUSHION

HIGH RESILIENT FOAM

UPHOLSTERY

TIGHT



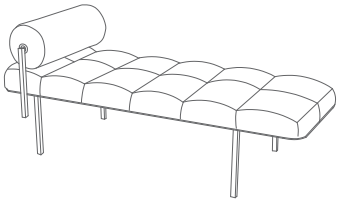

Catalog product-fabric

N-B28/Boucle



03

N-D11/Faux Leather



60501

Catalog product-Legs

Black painted metal leg





MASTERFUL LUXURY AND COMFORT





YUI BED

TECHNICAL SPECIFICATIONS

INTERIOR STRUCTURE

FRAME BEECH CONTRA

BACK CUSHION

35 DNS SOFT FOAM AND FIBER

UPHOLSTERY

TIGHT

MAINTENANCE

We recommend shaking and fluffing-up the cushions regularly to maintain the shape. This should be done after removing the cushions from the structure for improved air circulation. For maintenance of fabric and leather, please contact your retailer.



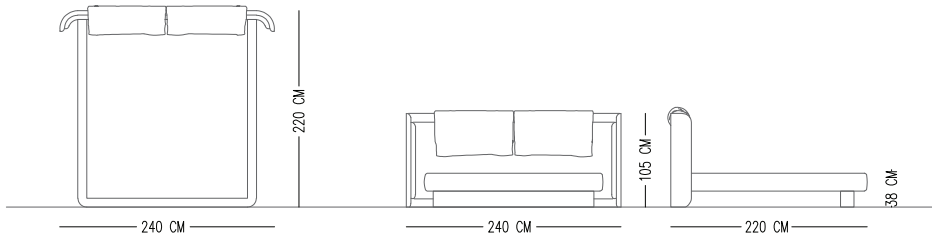
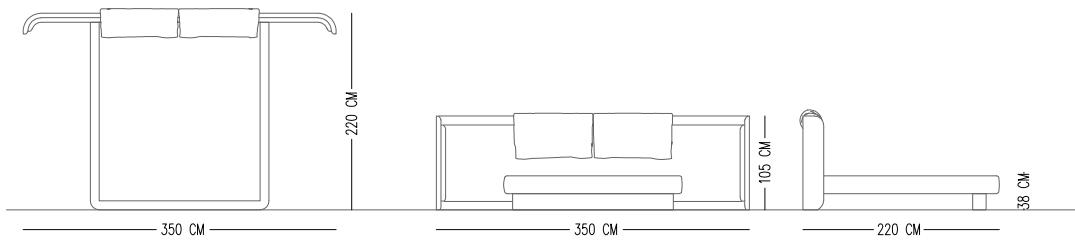

Catalog product

Catalog product-Fabric
N-A42



Pearl



DOMINO BED

TECHNICAL SPECIFICATIONS

INTERIOR STRUCTURE	FRAME BEECH CONTRA
BACK CUSHION	35 DNS SOFT FOAM AND FIBER
UPHOLSTERY	TIGHT
LEGS	BLACK METAL
MAINTENANCE	We recommend shaking and fluffing-up the cushions regularly to maintain the shape. This should be done after removing the cushions from the structure for improved air circulation. For maintenance of fabric and leather, please contact your retailer.



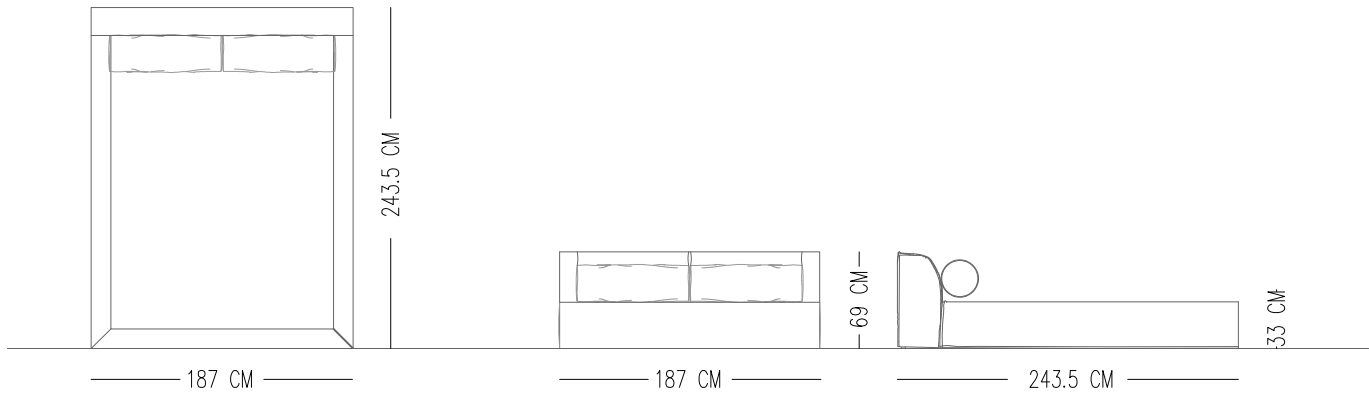

Catalog product

Catalog product-Fabric
N-A15/Nubuck

Catalog product-Legs
Hidden leg



016

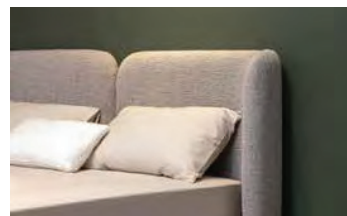
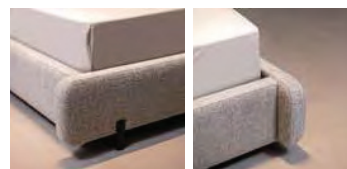
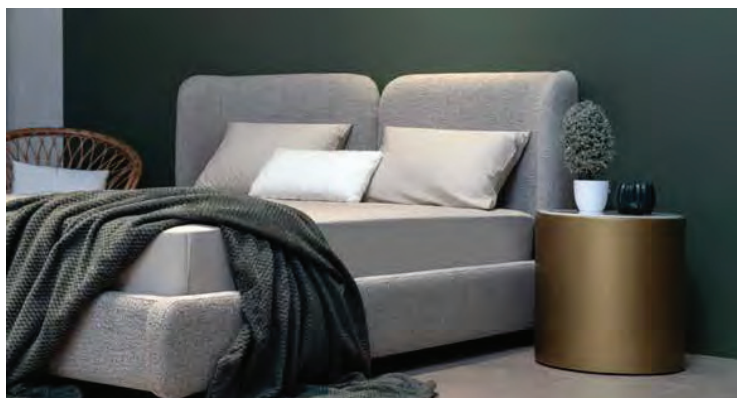

ANGE BED

TECHNICAL SPECIFICATIONS

INTERIOR STRUCTURE FRAME BEECH CONTRA

BACK CUSHION 35 DNS SOFT FOAM AND FIBER

UPHOLSTERY TIGHT

MAINTENANCE We recommend shaking and fluffing-up the cushions regularly to maintain the shape. This should be done after removing the cushions from the structure for improved air circulation. For maintenance of fabric and leather, please contact your retailer.



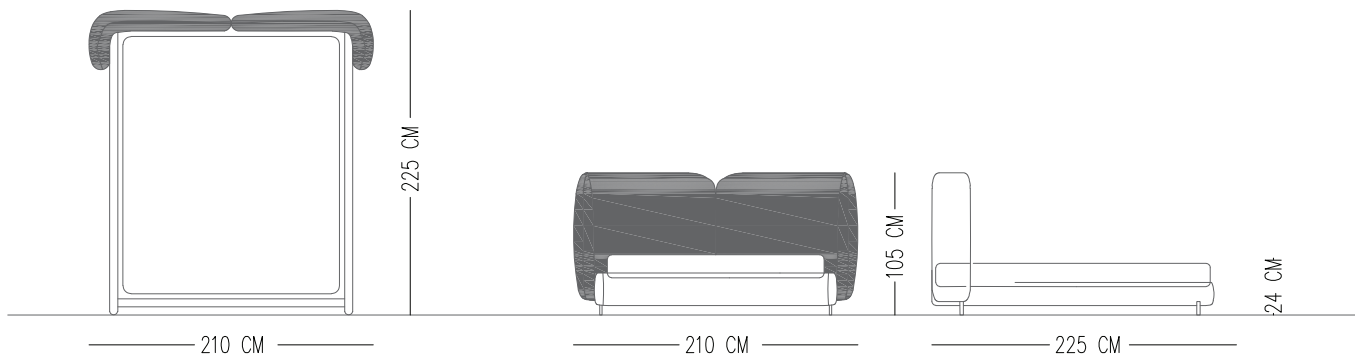

Catalog product

Catalog product-Fabric
N-B12/Boucle
V-12



Black painted metal





NORA BED

TECHNICAL SPECIFICATIONS

INTERIOR STRUCTURE FRAME BEECH CONTRA

BACK CUSHION 35 DNS SOFT FOAM AND FIBER

UPHOLSTERY TIGHT

MAINTENANCE We recommend shaking and fluffing-up the cushions regularly to maintain the shape. This should be done after removing the cushions from the structure for improved air circulation. For maintenance of fabric and leather, please contact your retailer.



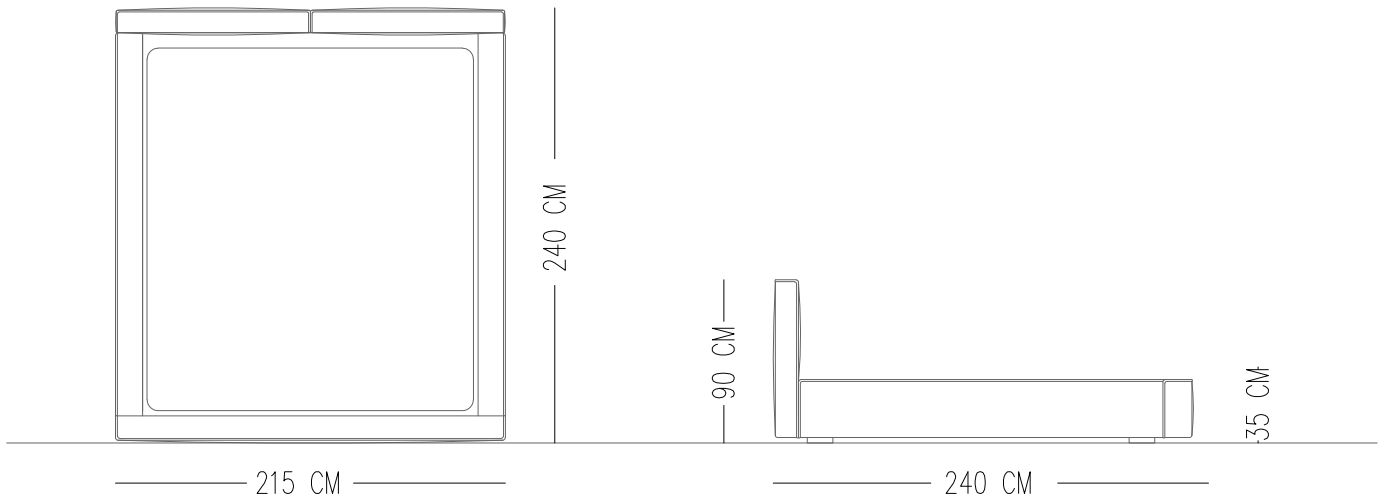

Catalog product

Catalog product-Fabric
N-B28/Boucle
09



Leg
Hidden metal leg



BULUT BED

TECHNICAL SPECIFICATIONS

INTERIOR STRUCTURE FRAME BEECH CONTRA

BACK CUSHION 35 DNS SOFT FOAM AND FIBER

UPHOLSTERY TIGHT

MAINTENANCE We recommend shaking and fluffing-up the cushions regularly to maintain the shape. This should be done after removing the cushions from the structure for improved air circulation. For maintenance of fabric and leather, please contact your retailer.



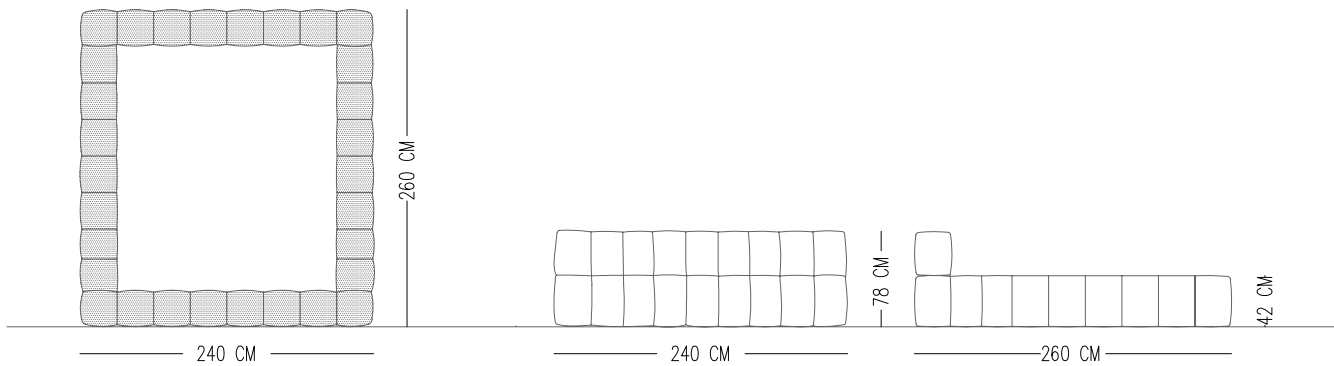

Catalog product

Catalog product-Fabric
N-B31/Chenille
1819



Leg
Hidden metal leg



FER BED

TECHNICAL SPECIFICATIONS

INTERIOR STRUCTURE FRAME BEECH CONTRA

BACK CUSHION 35 DNS SOFT FOAM AND FIBER

UPHOLSTERY TIGHT

MAINTENANCE We recommend shaking and fluffing-up the cushions regularly to maintain the shape. This should be done after removing the cushions from the structure for improved air circulation. For maintenance of fabric and leather, please contact your retailer.



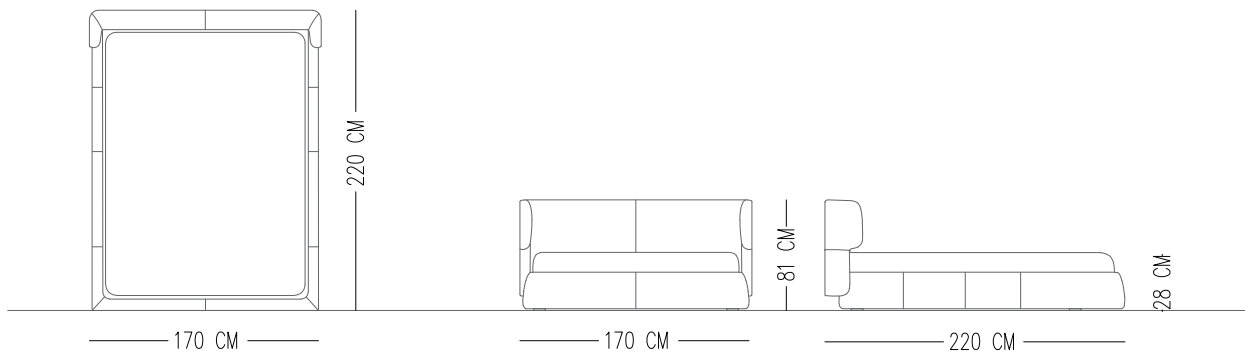

Catalog product

Catalog product-Fabric
N-A10/Linen
40540



Leg
Hidden metal leg



VERA POUF

TECHNICALS PECIFICATIONS

INTERIOR STRUCTURE PLYWOOD & FIBER

PADDING 35 DNS SOFT FOAM



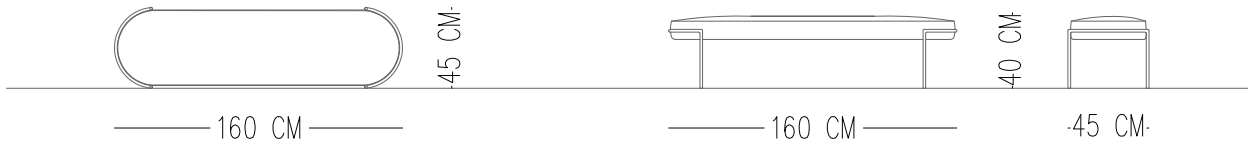
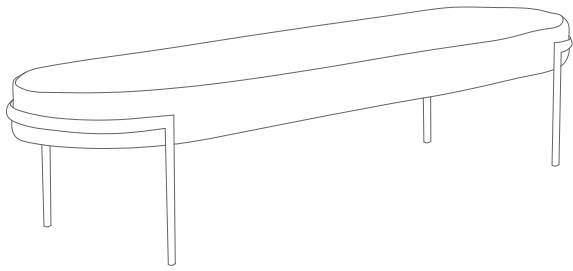

Catalog product-fabric

Linen-NA15



086

Catalog product-Legs

Painted Metal Leg





VERDE POUF

TECHNICALS PECIFICATIONS

INTERIOR STRUCTURE PLYWOOD & FIBER

PADDING 35 DNS SOFT FOAM



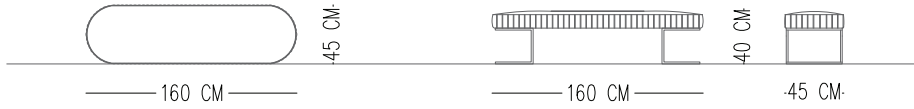
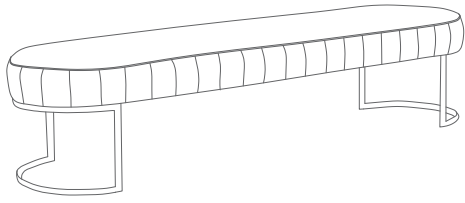

Catalog product-fabric

Linen-NA15



086

Catalog product-Legs

Painted Metal Leg





YUI NIGHT STAND-1

TECHNICAL SPECIFICATIONS

- 1 PRESS OPEN DRAWER/ LAQUER PAINTED WOOD- SILK MAT-COLOR
- 2 PORCELAIN CERAMIC INSIDE TABLE-5 MM
- 3 TOP OF TABLE-GLASS-8 MM



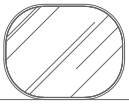

45 CM-

-57 CM-

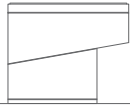

-57 CM-

47.5 CM

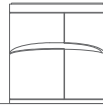

-45 CM-

Catalog product

Catalog product
Structure&drawer

Lacquer Painted On Wood
Soft touch



Catalog product
Top of table

Bronze Glass



Catalog product
Inside table

Calacatta Michelangelo Polish





YUI NIGHT STAND-2

TECHNICAL SPECIFICATIONS

- 1 PRESS OPEN DRAWER/ LAQUER PAINTED WOOD- SILK MAT-COLOR
- 2 PORCELAIN CERAMIC INSIDE TABLE-5 MM
- 3 TOP OF TABLE-GLASS-8 MM



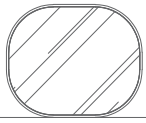

45 CM-

-55 CM-

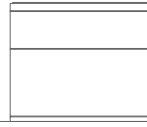

47.5 CM

-55 CM-

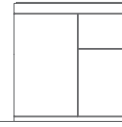

-45 CM-

Catalog product

Catalog product
Structure&drawer

Lacquer Painted On Wood
Soft touch



Catalog product
Top of table

Bronze Glass



Catalog product
Inside table

Calacatta Michelangelo Polish





ROUND NIGHT STAND

TECHNICAL SPECIFICATIONS

BASE AND DRAWER/SMOKED OAKWOOD VENEERING TRANSPARENT MAT SANDBLASTED FINISH

TOP: MARBLE: CALACATTA MICHELANGELO





Catalog product

Sandblasted Oakwood Veneering
Black Polish Varnish



Porcelain Ceramic-
Calacatta
Michelangelo-polish





LILY NIGHT STAND

TECHNICAL SPECIFICATIONS

STRUCTURE SANDBLASTED OAK WOOD VENEERING WITH BLACK VARNISHTWO DRAWER



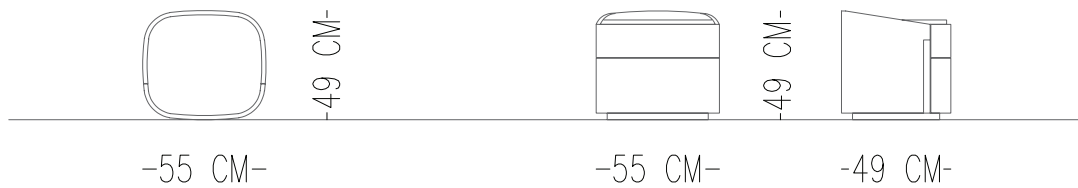

Catalog product

Sandblasted Oakwood Veneering
Poliform Black Varnish





YUI CHEST OF DRAWERS

TECHNICAL SPECIFICATIONS

- 1 OPENING CABINET / LAQUER PAINTED WOOD- SILK MAT-COLOR
- 2 LEATHER COVER BACK MIRROR
- 3 LAQUER PAINTED WOOD-SILK MAT COLOR-PUSH OPEN COVER



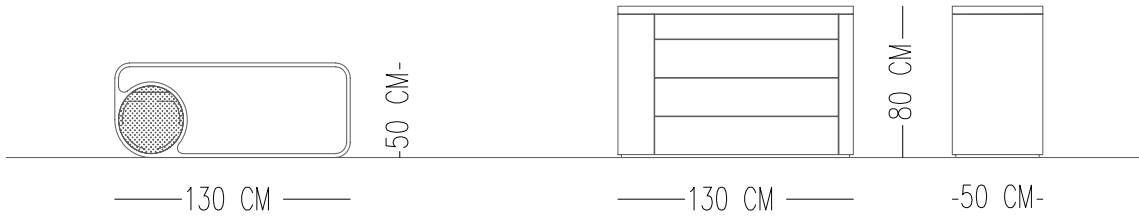

Catalog product

Catalog product

Lacquer Painted On Wood
Soft touch



Leather Cinnamon



Clear Mirror



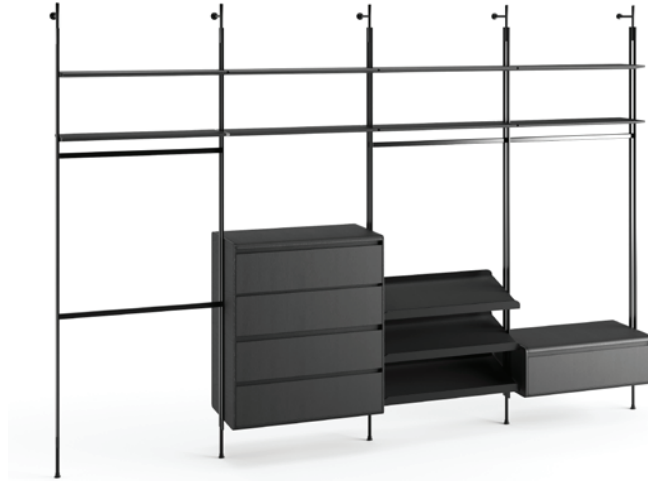

MARLON WALK-IN WARDROBE

TECHNICAL SPECIFICATIONS

STRUCTURE PROFILE MAT SILVER METALLIC FINISH

SHELVES AND DRAWERS OAK WOOD VENEERING WITH NATURAL VARNISH -SANDBLASTED FINISH



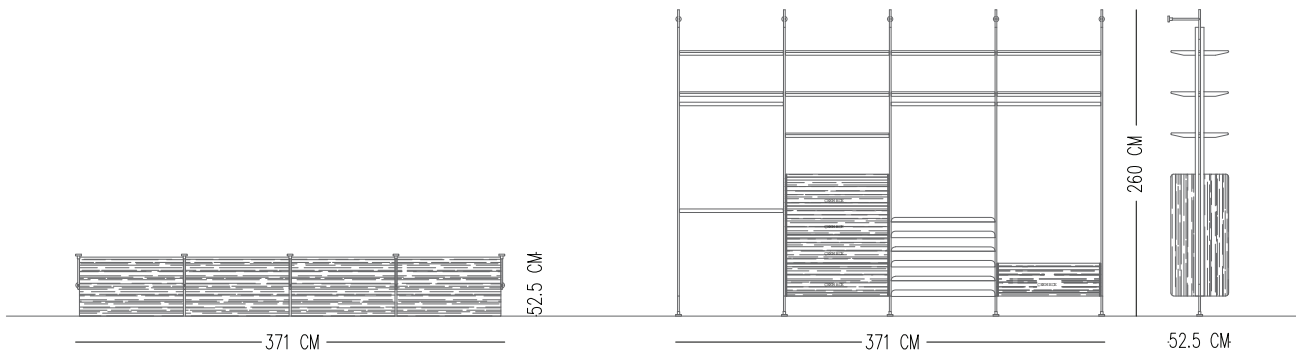

Catalog product

Structure
Shelves/Drawers



Oak wood Veneering
Black Varnish-sandblasted finish

Legs
Black metal finish



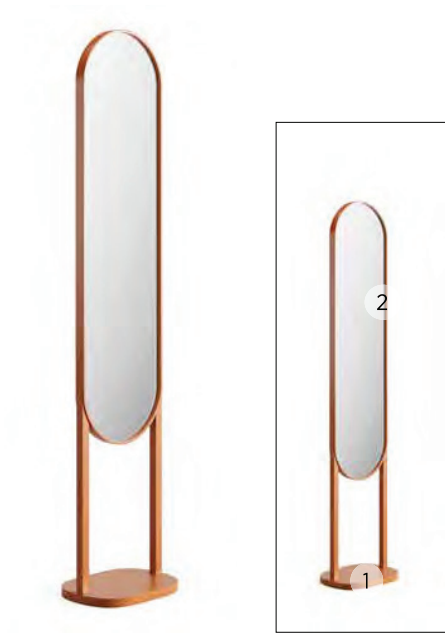

YUI FREESTANDING MIRROR

TECHNICAL SPECIFICATIONS

- 1 METAL CONSTRUCTION
- 2 MIRROR

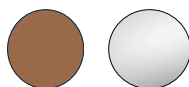

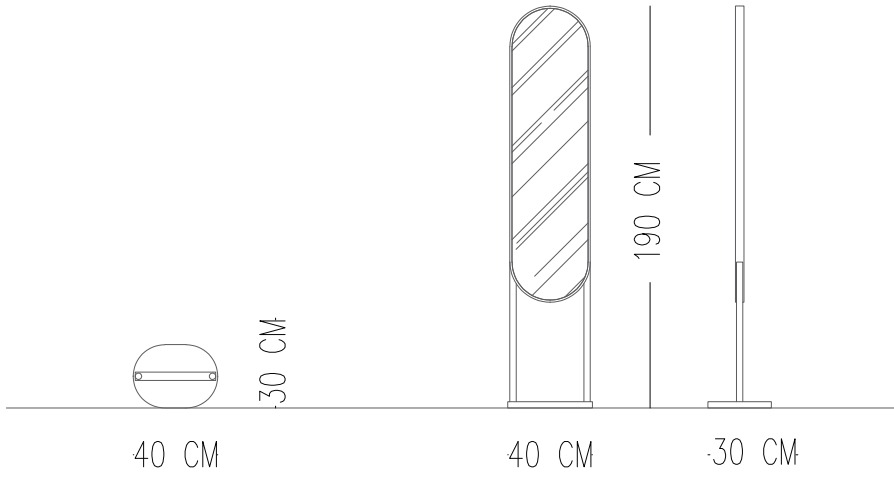

Catalog product

Metal Mirror Unit
Metal-Cinnamon



Clear Mirror





BEAN MIRROR

TECHNICAL SPECIFICATIONS

FABRIC COVERED FRAME
CLEAR MIRROR

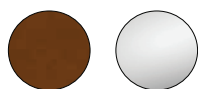

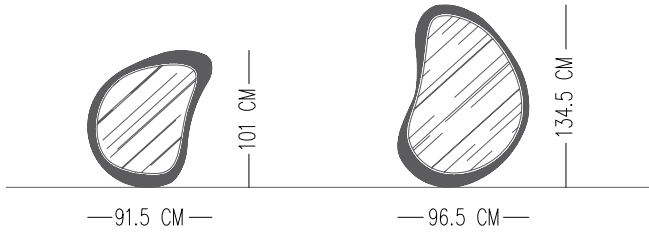
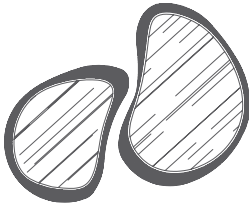

Catalog product

Catalog product-fabric
N-B45/Nubuck



Clear Mirror



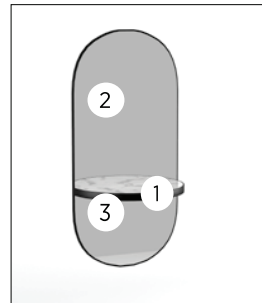

- 1 PORCELAIN CERAMIC SHELF
- 2 CLEAR MIRROR
- 3 PAINTED METAL BLACK

OVUS MIRROR

TECHNICAL SPECIFICATIONS

FRAME STRUCTURE

ELECTROSTATIC PAINT ON METAL
CLEAR MIRROR
MARBLE SHELF

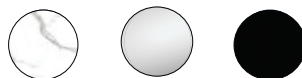

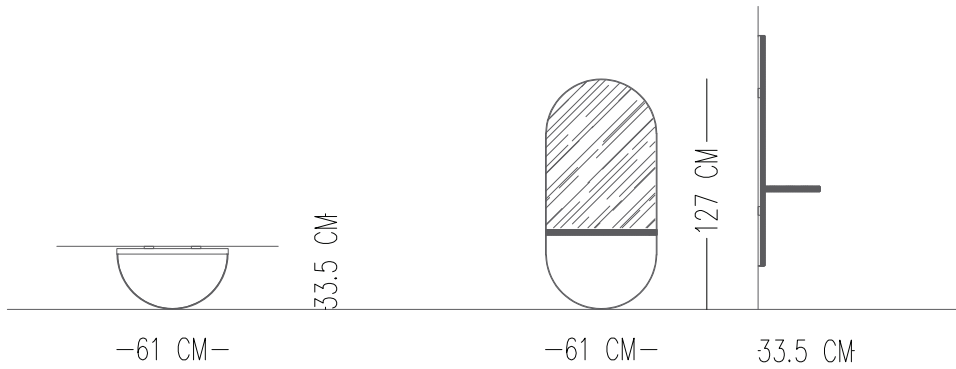
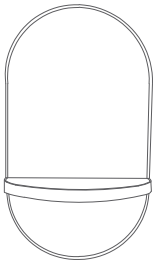

Catalog product

Frame Structure
Painted metal black



Clear Mirror



Porcelain ceramic-calacatta





SHERLOCK SEPARATOR

TECHNICAL SPECIFICATIONS

- 1 METAL CONSTRUCTION AND FABRIC COVERED WOOD
- 2 MIRROR
- 3 METAL HANGER



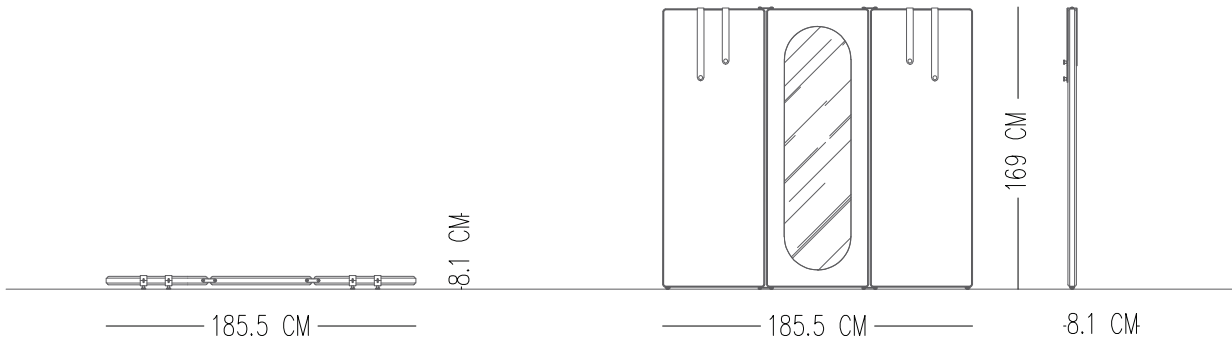

Catalog product

N-B45/Nubuck



103 Beige

Clear Mirror



Painted Metal





OLIVER SEPERATOR

TECHNICAL SPECIFICATIONS

FRAME STRUCTURE

ELECTROSTATIC PAINT ON METAL

SHELVES

NATURAL OAK VENEERING (MATT POLISHED)



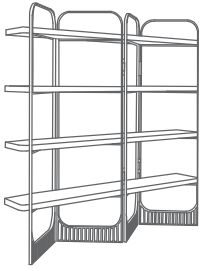

—170 CM—

36.5 CM

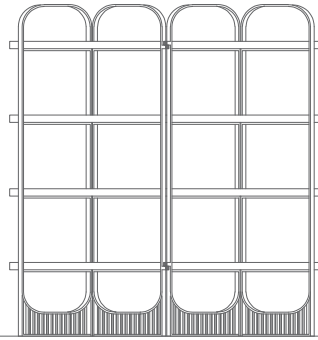

—170 CM—

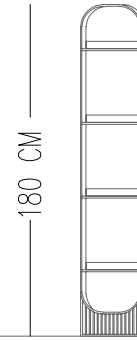

180 CM

-36.5 CM-

Catalog product

Frame Structure
Painted metal 07 cooper metal finish



Shelves
Oak Wood Veneering
with natural varnish





SEBASTIAN HANGER

TECHNICAL SPECIFICATIONS

FRAME STRUCTURE

ELECTROSTATIC PAINT ON METAL
WALNUT VENEERING WOODEN BASE

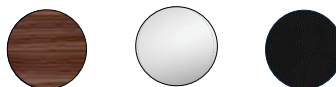

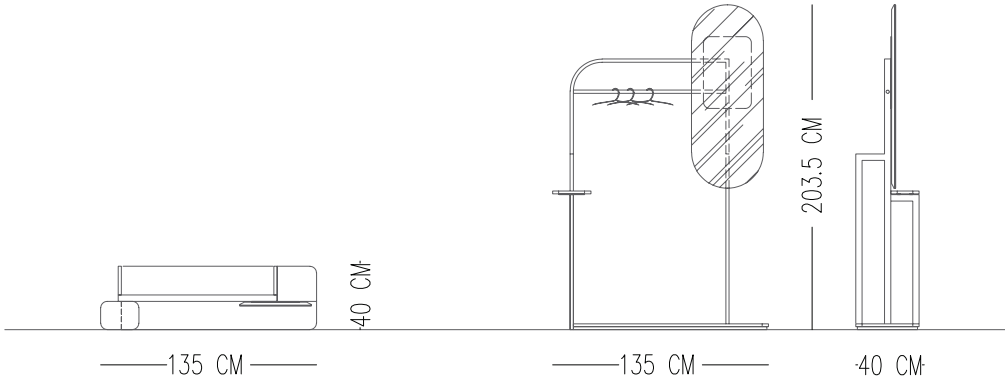
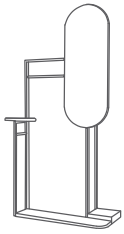

Catalog product

Frame Structure
Painted metal black



Clear Mirror



Walnut wood



CONTRACT

SitForm.
redefine your space

ARMCHAIR COLLECTION



Yui



Mona



Rio



Tom



Audrey



Lora



Vibe



Norden



Eva



Nora



Drop



Cherry



Zeta



Bear



Dari

SOFA COLLECTION



Yui



Audrey



Venedik



Jupiter



Domino



Ange



Vibe



Bulut



Somet
Samet Bakır



Vientos



Itals



Clementine



Leo



Porto



Marlon



Bilgin

COFFEE/SIDE TABLE COLLECTIONS



Yui



Audrey



Drank



Yui



Marlon



Shot



Yui



Bulut



Anatolia



Kiena



Marlon



Oliver



Kiena



Domino



Audrey



Drank

TABLE /SIDE BOARD/TV UNIT/CONSOLE COLLECTIONS



Yui



Audrey



Clementine



Yui Console Table



Clementine



Audrey



Domino Console Table

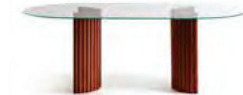

Oliver



Clementine



Mona Console Table



Costa



Mojo



Audrey Console Table



Marlon

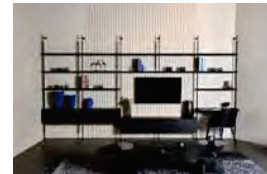

Marlon



Patmos



Audrey



Pietra

CHAIR COLLECTIONS



Aston



Parc



Clementine



Partner



Audrey



Lotus



Corvus



Mona



Bilgin



Random



Minnie

BED/NIGHT STAND/MIRROR/SEPERATOR COLLECTIONS



Yui



Yui



Bilgin Sofa Bed



Yui

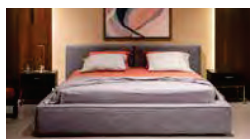

Nora



Vera



Yui



Fer



Verde



Yui Nighth Stand 2



Domino



Oliver



Round Nighth Stand



Bulut



Sebastian



Ovus



Lily Nighth Stand

OUTDOOR COLLECTIONS



Nano Armchair



Flat Stool



Pera Bar Stool



Fear Outdoor



Mushroom Stool



Wonder Bar Stool



Fear Outdoor



Ube Stool



Astra Round Table



Drop Outdoor



Ottoman Coffee Table



Astra Coffee Table



Benay Outdoor



Audrey



Oliver



Clementine

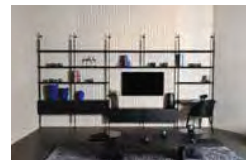

Marlon

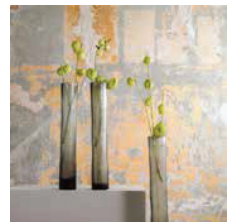



Lora



Ange



Kiena



Somet



Drop



Kiena



Mona



Marlon



Audrey



Audrey



Audrey

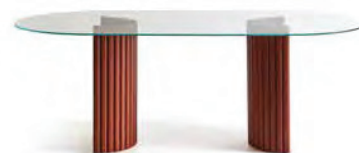

Oliver



Mona



Oliver



Lotus



Oliver



Audrey

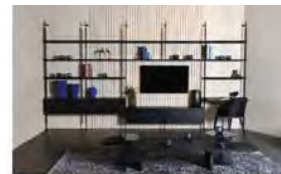

Marlon



Clementine



Clementine







Domino



Audrey



Mojo



Domino



Oliver



Domino



Domino



Marlon



Marlon



Marlon



Domino



Oliver



Dari



Drank



Dari



Marlon



Marlon



Benay

OUTDOOR

SitForm.
redefine your space



ZEN SOFA

TECHNICAL SPECIFICATIONS

STRUCTURE

NATURAL COLOR BAMBOO



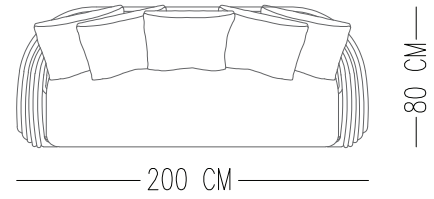
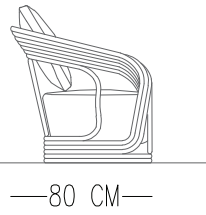
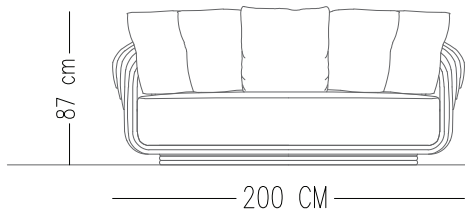

Catalog product



Natural bamboo color



ZEN ARMCHAIR

TECHNICAL SPECIFICATIONS

STRUCTURE

NATURAL COLOR BAMBOO



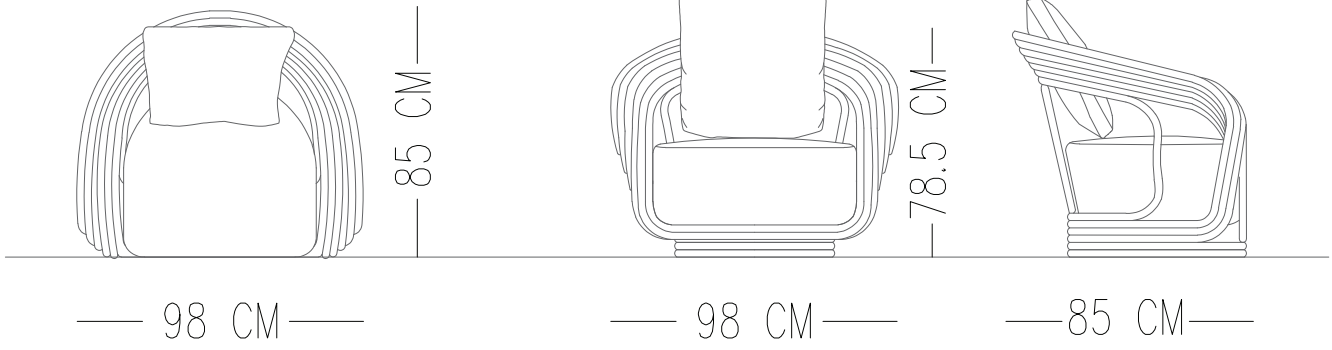

Catalog product



Natural bamboo color



ZEN COFFE TABLE

TECHNICAL SPECIFICATIONS

STRUCTURE

NATURAL BAMBOO WOOD COFFEE TABLE



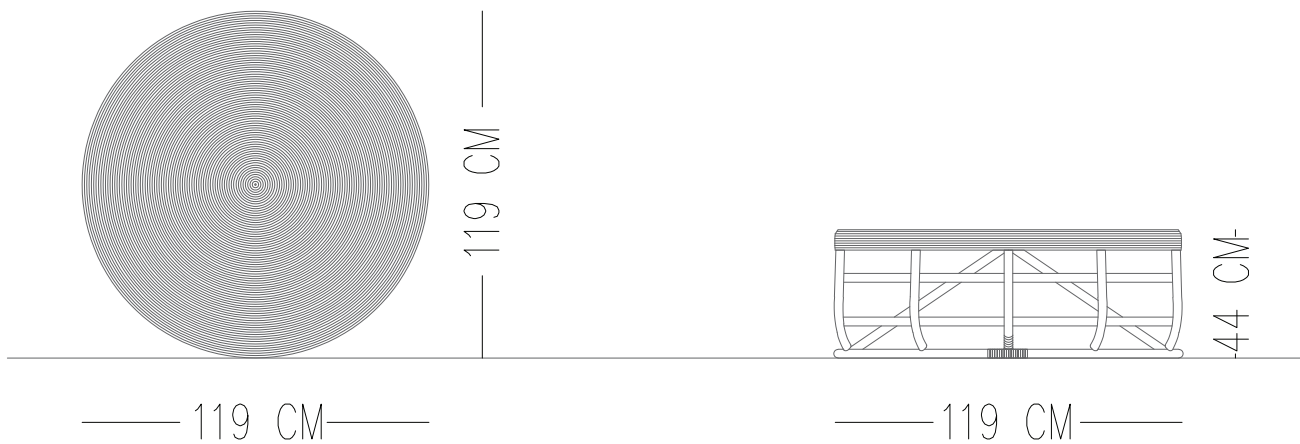

Catalog product

Natural bamboo



Wood



OASIS SOFA

TECHNICAL SPECIFICATIONS

STRUCTURE	POLY BAMBOO HDPE WICKER
	WATER RESISTANT FABRIC
	7CM THICKNESS CUSHION, PIPING.



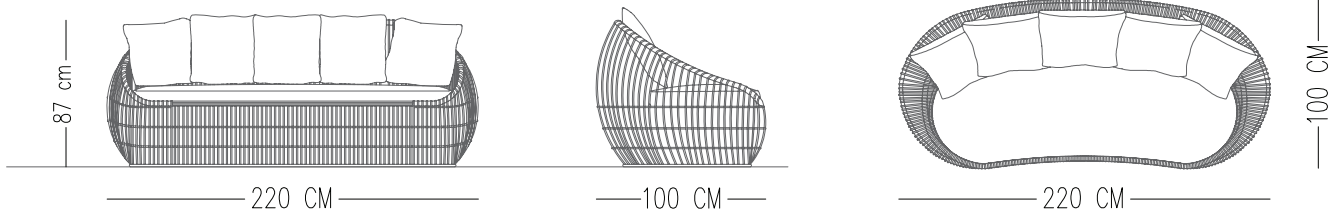

Catalog product



Natural bamboo
round rattan



OASIS ARMCHAIR

TECHNICAL SPECIFICATIONS

STRUCTURE

POLY BAMBOO HDPE WICKER

WATER RESISTANT FABRIC

7CM THICKNESS CUSHION, PIPING.



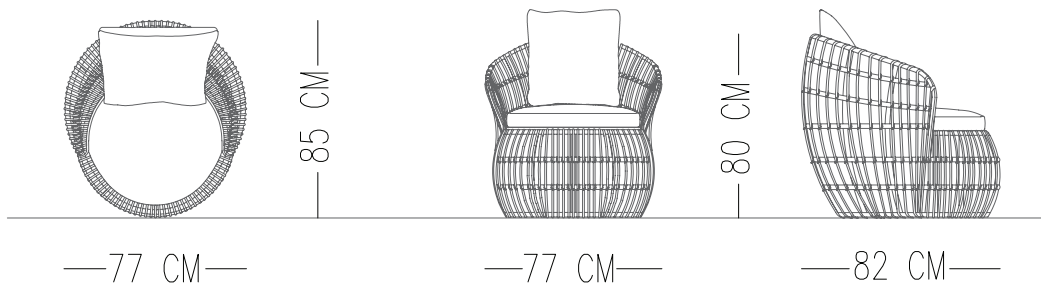

Catalog product



Natural bamboo
round rattan



OASIS COFFE TABLE

TECHNICAL SPECIFICATIONS

STRUCTURE

NATURAL BAMBOO WOOD COFFEE TABLE



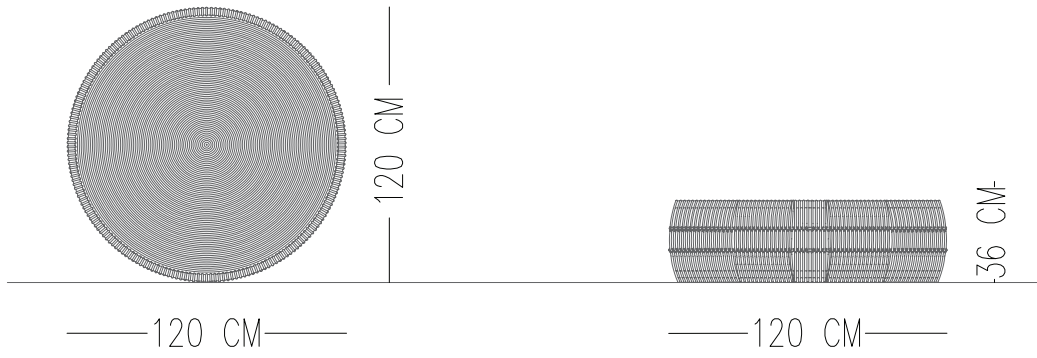

Catalog product

Natural bamboo



Wood

Natural bamboo



Round Rattan



WONDER BAR STOOL

TECHNICAL SPECIFICATIONS

STRUCTURE

TEAK WOOD WITH NATURAL TEAK COLOR VARNISH



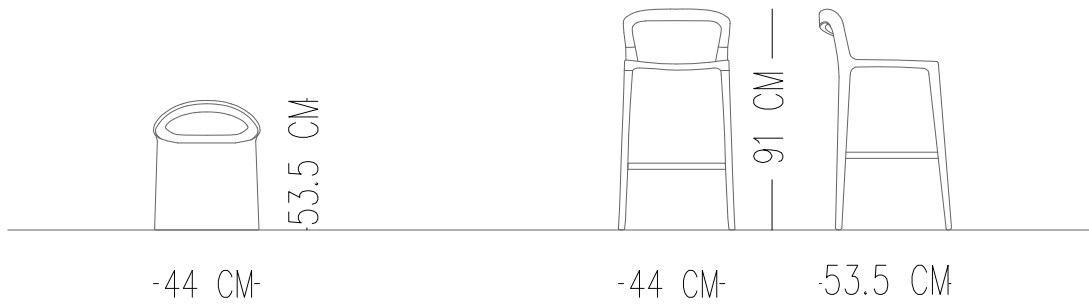

Catalog product



Teak color with natural
teak color varnish

Alternative material: Teak wood black finishes,
White patinated teak wood



PERA COUNTER CHAIR

TECHNICAL SPECIFICATIONS

STRUCTURE

TEAK WOOD BLACK FINISHING

ALTERNATIVE: TEAK WOOD WHITE WASH FINISHING



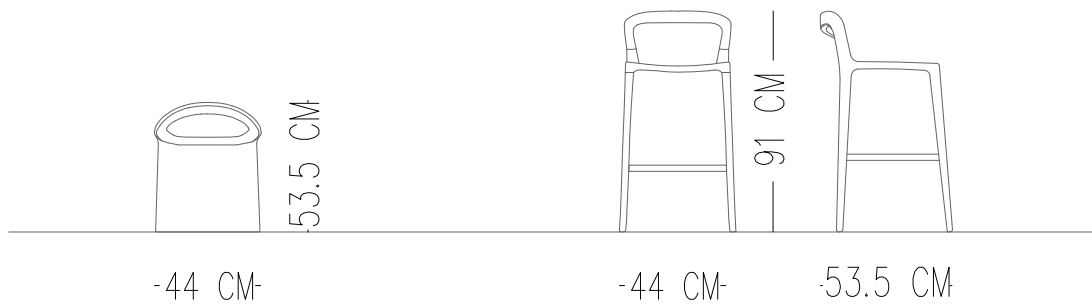

Catalog product



Teak color with natural
teak color varnish

Alternative material: Teak wood black finishes,
White patinated teak wood



NANO ARMCHAIR

TECHNICAL SPECIFICATIONS

STRUCTURE

TEAK WOOD-NATURAL TEAK COLOR



Catalog product



Teak color with natural teak color

Alternative material:Teak wood black finishes,
White patinated teak wood



MUSHROOM STOOL

TECHNICAL SPECIFICATIONS

STRUCTURE TEAK WOOD NATURAL TEAK COLOR
ALTERNATIVE: TEAK WOOD BLACK



Catalog product



Teak color with natural teak color

Alternative material:Teak wood black finishes,
White patinated teak wood



FLAT STOOL

TECHNICAL SPECIFICATIONS

STRUCTURE

TEAK WOOD LAMINATED NATURAL FINISHING



Catalog product



Teak color with natural teak color

Alternative material:Teak wood black finishes,
White patinated teak wood



UBE STOOL

TECHNICAL SPECIFICATIONS

STRUCTURE

TEAK WOOD LAMINATED BLACK FINISHING



Catalog product



Teak Wood Laminated Black
Finishing

Alternative material: Teak wood black finishes,
White patinated teak wood



ASTRA COFFEE TABLE

TECHNICAL SPECIFICATIONS

STRUCTURE

TOP: NATURAL STONE

BASE: NATURAL WOOD



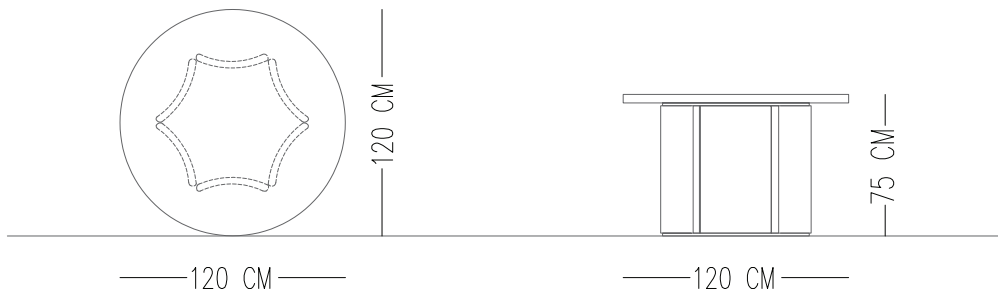

Catalog product

Top
Natural stone



Catalog product

Legs
Natural wood



Alternative material
Legs are natural wood painted black



ASTRA ROUND TABLE

TECHNICAL SPECIFICATIONS

STRUCTURE TOP: NATURAL STONE
 BASE: NATURAL WOOD



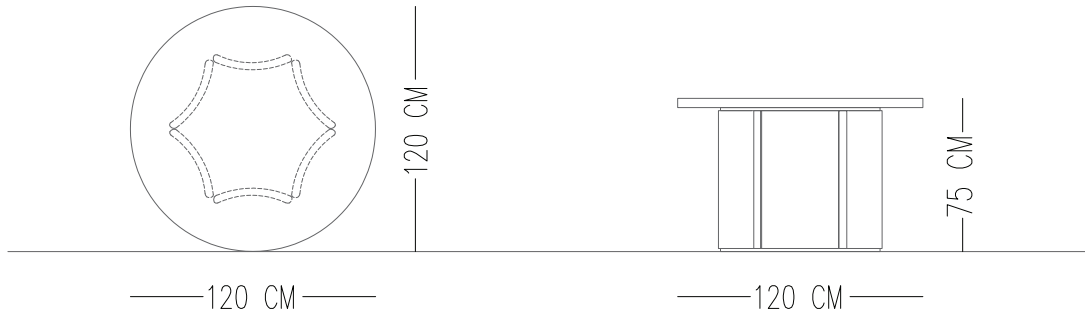

Catalog product

Top
Natural stone



Catalog product

Legs
Natural wood





OTTOMAN COFFEE TABLE

TECHNICAL SPECIFICATIONS

STRUCTURE

WOOD BLACK COLOR

ALTERNATIVE: WHITE WASH FINISHING



Catalog product



Wood Black Color

Alternative material: Teak wood black finishes,
White patinated teak wood

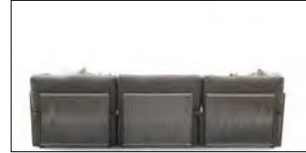

BENAY OUTDOOR

TECHNICAL SPECIFICATIONS

INTERIOR STRUCTURE	PLYWOOD STRUCTURE BEECHWOOD & OUTDOOR PAINTED METAL
SEAT CUSHION	35 DNS FOAM & OUTDOOR FIBER
BACK	35 DNS FOAM & OUTDOOR FIBER
UPHOLSTERY	TIGHT
MAINTENANCE	We recommend shaking and fluffing-up the cushions regularly to maintain the shape. This should be done after removing the cushions from the structure for improved air circulation. For maintenance of fabric and leather, please contact your retailer.



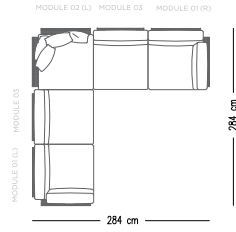
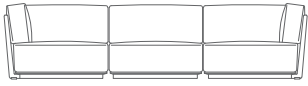

STANDARDS

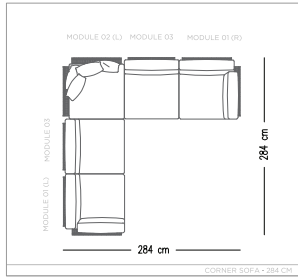

MODULES

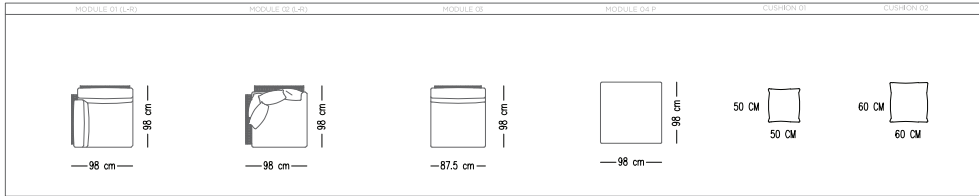

Catalog product

Catalog product-Fabric
N-C16/Linen



337

Catalog product
Aluminium profile



DROP SOFA 2

TECHNICAL SPECIFICATIONS

INTERIOR STRUCTURE IROKO WOOD & 35 DNS FOAM WITH ZIGZAG BOW

SEAT CUSHION 35 DNS FOAM

BACK FIBER

UPHOLSTERY TIGHT

MAINTENANCE We recommend shaking and fluffing-up the cushions regularly to maintain the shape. This should be done after removing the cushions from the structure for improved air circulation. For maintenance of fabric and leather, please contact your retailer.



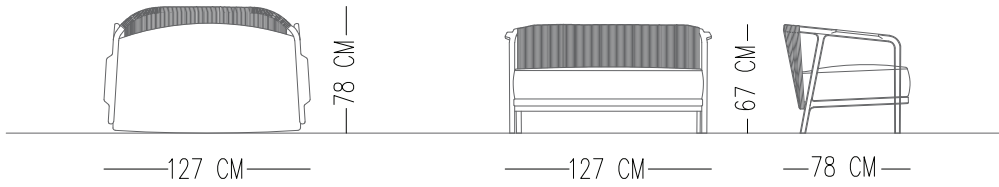
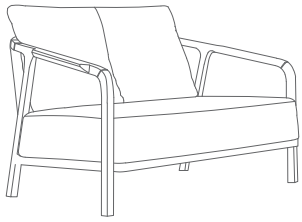

Catalog product

Catalog product-Fabric
Linen-NB40



Laci-01

Light Grey
Outdoor Rope



Catalog product
Iroko hardwood with
natural polish



FEAR OUTDOOR

TECHNICAL SPECIFICATIONS

INTERIOR STRUCTURE BEECHWOOD

SEAT CUSHION 35 DNS FOAM AND FIBER

BACK FIBER

UPHOLSTERY TIGHT

MAINTENANCE We recommend shaking and fluffing-up the cushions regularly to maintain the shape. This should be done after removing the cushions from the structure for improved air circulation. For maintenance of fabric and leather, please contact your retailer.



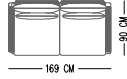
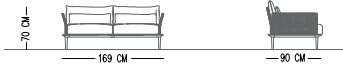
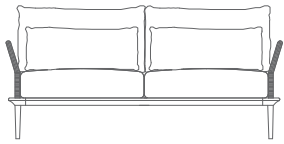

STANDARDS

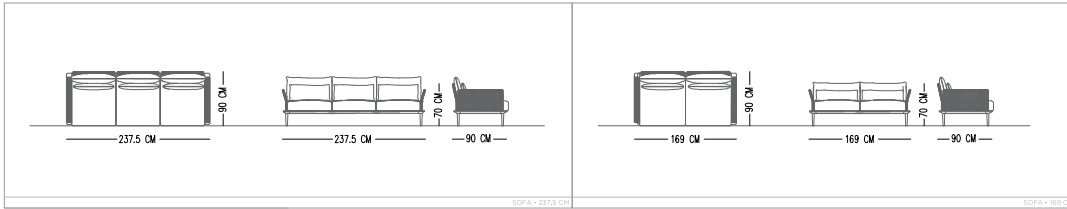

MODULES

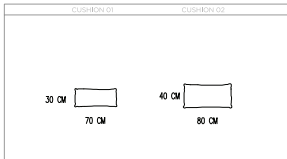

Catalog product

Catalog product-Fabric
N-C16/Linen

Leg
Aluminium



168



FEAR OUTDOOR

TECHNICAL SPECIFICATIONS

INTERIOR STRUCTURE BEECHWOOD

SEAT CUSHION GOOSE DOWN AND SILICON MIX

BACK BACK CUSHION 100% DOWN/FEATHERS

UPHOLSTERY TIGHT

MAINTENANCE We recommend shaking and fluffing-up the cushions regularly to maintain the shape. This should be done after removing the cushions from the structure for improved air circulation. For maintenance of fabric and leather, please contact your retailer.



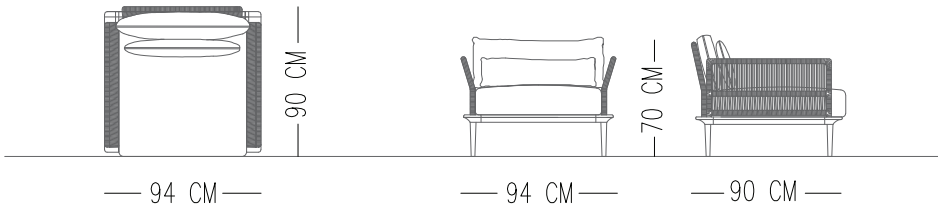
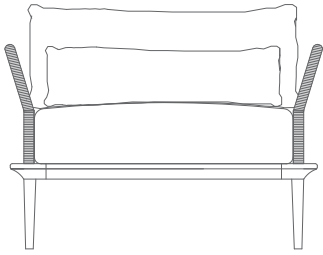

Catalog product

Catalog product-Fabric
N-C16/Linen

Leg
Aluminium





168

SitForm.
redefine your space

SitForm.

redefine your space

+387 61 927171
info@sitform.ba

 SitForm.
 sitform.sarajevo
www.sitform.ba

Kolodvorska 12
Krug TC Intershop-a
71 000 Sarajevo